



VINCENT
SHEPPARD

outdoor
collection
2024

INDEX

COLLECTIONS

ANTON	11	MAX	108
BISTRO TABLES	108	MAYA	92
CLEO	46	MIA	153
CLIFF	74	MONA	54
DAVID	76	MORA	92
EDGARD	120	NOA	54
FREYA	54	ODA	12
FRIDA	4	OLAF	109
GIPSY	120	OTTO	169
IVO	132 154	REMI	54
KENZO	153	ROXANNE	109
KODO	20	ROXY	109
LENA	120	ROY	102
LENTO	38	ROZY	111
LEO	64	SAFI	144
LIGHT MY TABLE	92	SAM	11
LILO	53	TIKA	92
LOOP	84	TOUNDRA	74
LLOYD LOOM	156	VOLTA	54
LUCY	134	WICKED	112
MATTEO	130		

DECO CUSHIONS	168
---------------	-----

TECHNICAL INFORMATION	171
-----------------------	-----

FABRICS	174
---------	-----

PRODUCT OVERVIEW	177
------------------	-----

Finding comfort

Vincent Sheppard has been designing and manufacturing indoor and outdoor furniture with exceptional seating comfort since 1992. The company is worldwide market leader in Lloyd Loom furniture, a technique where kraft paper is twisted around a metal wire and woven into unique furniture pieces.

By constantly challenging itself and its design aesthetics, Vincent Sheppard is able to present young, contemporary furniture collections that answer to all modern needs. We combine a clear focus on quality and comfort with craftsmanship and an age-old technique, and translate these ingredients into qualitative, durable and appealing designs. With a wide variety of indoor as well as outdoor pieces of high quality, Vincent Sheppard is a favourite of many interior aficionados.

The Vincent Sheppard team

FRIDA

A distinctive design with a spacious back, round frame and tactile seat.
Beautiful from all sides and angles.



LOUNGE CHAIR - DINING CHAIR



FRIDA LOUNGE CHAIR anthracite
ANTON COFFEE TABLE



FRIDA DINING CHAIR anthracite



FRIDA DINING CHAIR anthracite
SAM DINING TABLE



FRIDA DINING CHAIR dune white
NOA DINING TABLE



FRIDA LOUNGE CHAIR

MATERIALS

untreated teak or black stained brushed teak
polypropylene rope

COLOUR



UNTREATED TEAK
ANTHRACITE ROPE



UNTREATED TEAK
DUNE WHITE ROPE



BRUSHED TEAK BLACK
ONYX BLACK ROPE

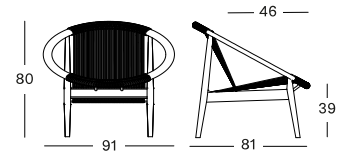

FRIDA DINING CHAIR

MATERIALS

untreated teak
polypropylene rope

COLOUR



UNTREATED TEAK
ANTHRACITE ROPE



UNTREATED TEAK
DUNE WHITE ROPE

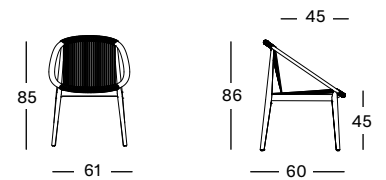

ANTON SIDE & COFFEE TABLE TEAK

MATERIALS

untreated teak

DIMENSIONS

- 40,5 cm H x Ø 40 cm
- 34,5 cm H x Ø 70 cm

COLOUR



UNTREATED TEAK

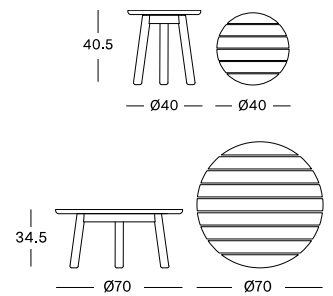

SAM DINING TABLE

MATERIALS

untreated solid teak

DIMENSIONS

75 cm H x Ø 120 cm

COLOUR



UNTREATED TEAK

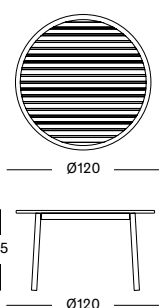

ODA

Warm teak, textured straps and pillow-like cushions create an ambiance that is both playful and inviting.



LOUNGE CHAIR - LOUNGE SOFA 2,5S - LOUNGE SOFA 3S - SIDE TABLE - COFFEE TABLE





LEFT PAGE: ODA COFFEE TABLES ceramic portland
RIGHT PAGE: ODA LOUNGE CHAIR





ODA LOUNGE CHAIR

MATERIALS

untreated teak
polypropylene straps

CUSHION

seat 14 cm quick dry foam
back polyester fibre filling

COLOURS



UNTREATED TEAK
FLAX STRAP

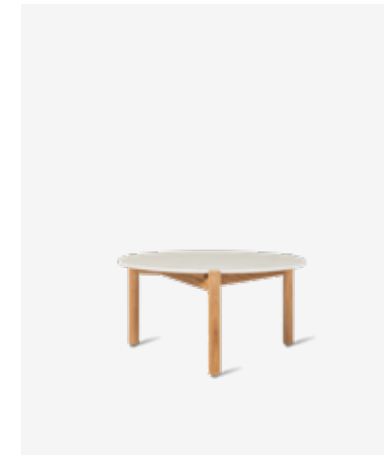
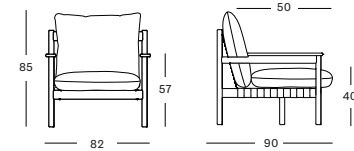

ODA COFFEE TABLE DIA 68

MATERIALS

untreated teak
ceramic

DIMENSIONS

35 cm H x Ø 68 cm

COLOURS



UNTREATED TEAK
FLINT CERAMIC UNTREATED TEAK
SHARDS CERAMIC UNTREATED TEAK
PORTLAND CERAMIC

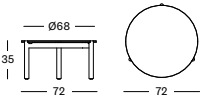

ODA LOUNGE SOFA 2,5S

MATERIALS

untreated teak
polypropylene straps

CUSHIONS

seat 14 cm quick dry foam
back polyester fibre filling

COLOURS



UNTREATED TEAK
FLAX STRAP

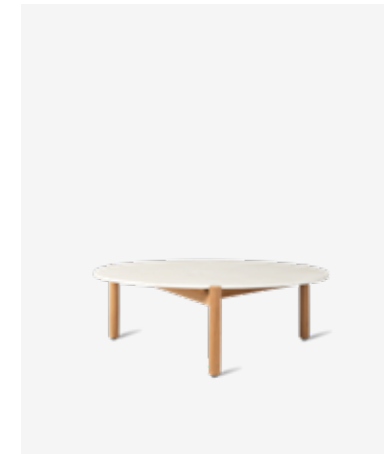
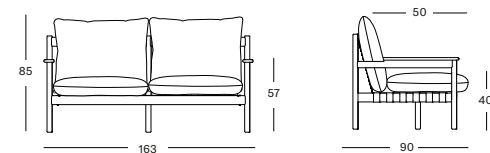

ODA COFFEE TABLE DIA 90

MATERIALS

untreated teak
ceramic

DIMENSIONS

30 cm H x Ø 90 cm

COLOURS



UNTREATED TEAK
FLINT CERAMIC UNTREATED TEAK
SHARDS CERAMIC UNTREATED TEAK
PORTLAND CERAMIC

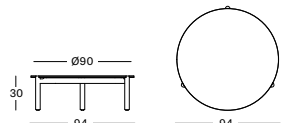

ODA LOUNGE SOFA 3S

MATERIALS

untreated teak
polypropylene straps

CUSHIONS

seat 14 cm quick dry foam
back polyester fibre filling

COLOURS



UNTREATED TEAK
FLAX STRAP

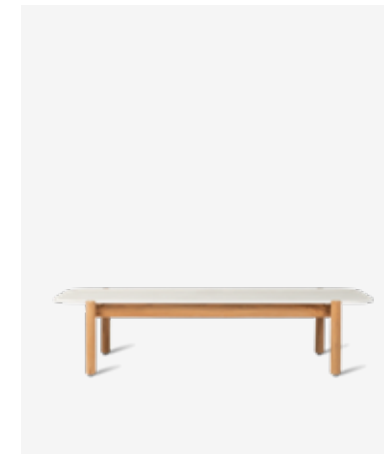
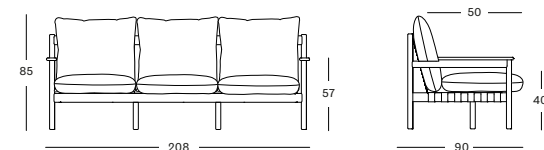

ODA COFFEE TABLE 129X53

MATERIALS

untreated teak
ceramic

DIMENSIONS

30 cm H x 53 cm x 129 cm

COLOURS



UNTREATED TEAK
FLINT CERAMIC UNTREATED TEAK
SHARDS CERAMIC UNTREATED TEAK
PORTLAND CERAMIC

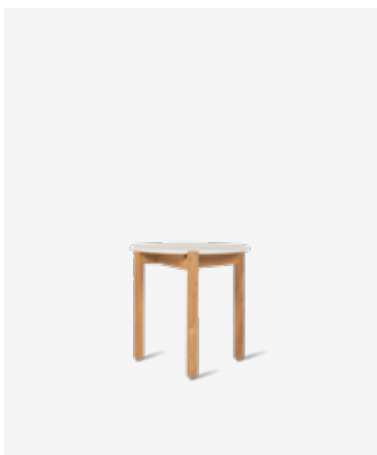

ODA SIDE TABLE DIA 45

MATERIALS

untreated teak
ceramic

DIMENSIONS

45 cm H x Ø 45 cm

COLOURS



UNTREATED TEAK
FLINT CERAMIC UNTREATED TEAK
SHARDS CERAMIC UNTREATED TEAK
PORTLAND CERAMIC

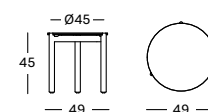

KODO

Contemporary outdoor elegance which beckons both comfort and style.
Designed by Studio Segers



MODULAR SOFA - DEEP SOFA - LOUNGE SOFA - LOUNGE CHAIR - COCOON - ROCKING CHAIR - FOOTREST
SUNLOUNGER - SIDE TABLE - COFFEE TABLE - DAYBED - DINING CHAIR - DINING TABLE



KODO DEEP SOFA AND MODULAR SOFA dune white
ROUND COFFEE TABLES dune white | ceramic portland



LEFT PAGE: KODO LOUNGE CHAIR, LOUNGE SOFA AND COFFEE TABLE dune white | ceramic shards
RIGHT PAGE: KODO ROCKING CHAIR AND SIDE TABLE dune white | ceramic shards





KODO DAYBED fossil grey
MORA LAMP MEDIUM AND LARGE



KODO LOUNGE CHAIR AND SOFA fossil grey
KODO COFFEE TABLE AND SIDE TABLE fossil grey | ceramic flint



KODO DINING CHAIR fossil grey
KODO DINING TABLE fossil grey | ceramic flint



LEFT PAGE: KODO COCOON dune white
RIGHT PAGE: KODO SUNLOUNGER dune white

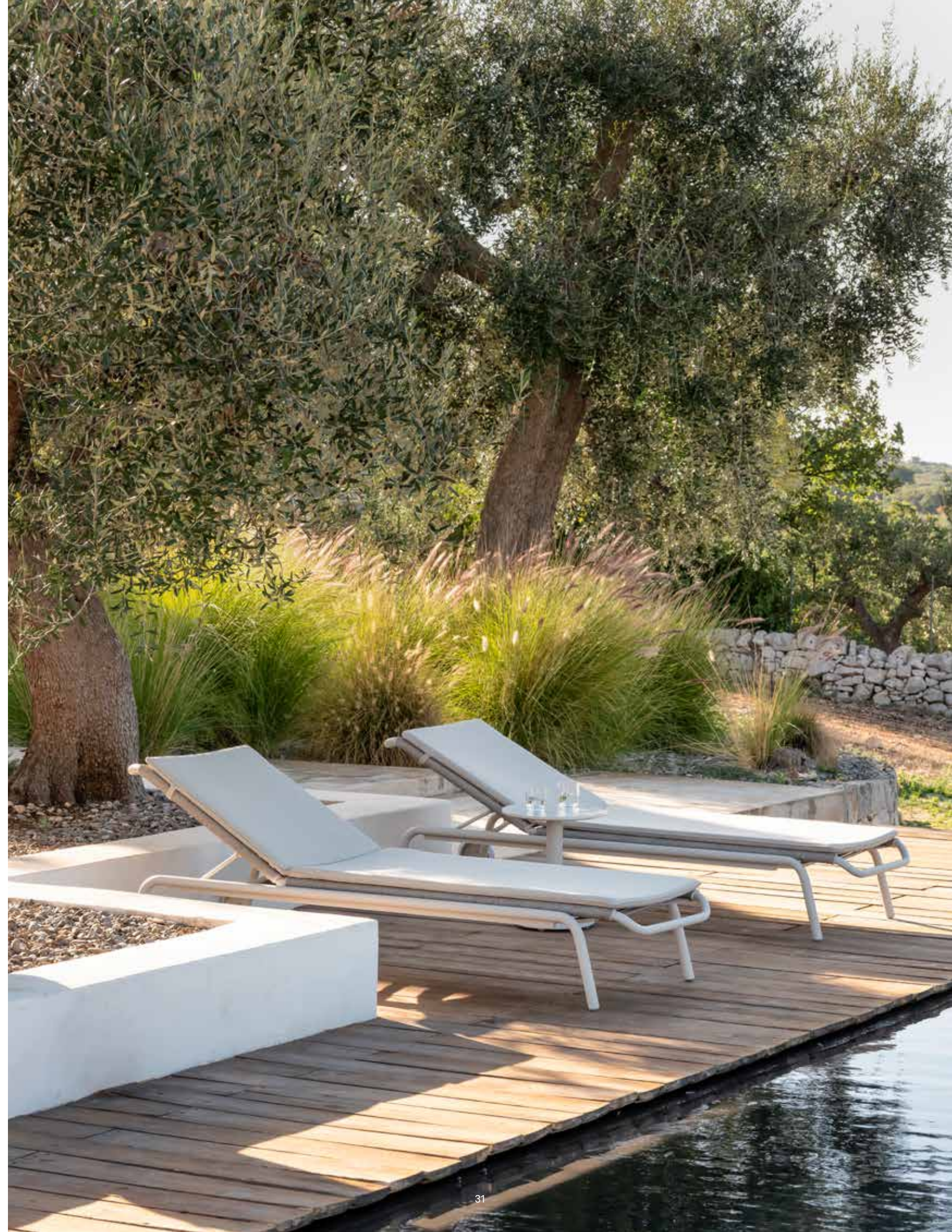



KODO DINING CHAIR

MATERIALS
powder coated aluminium
polypropylene rope

CUSHION
seat 4 cm quick dry foam

COLOURS

FOSSIL GREY **DUNE WHITE**

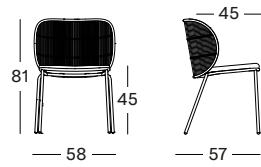

KODO FOOTREST

MATERIALS
powder coated aluminium

CUSHION
footrest 12 cm quick dry foam

COLOURS

FOSSIL GREY **DUNE WHITE**

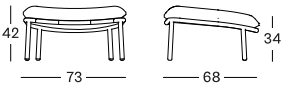

KODO COCOON

MATERIALS
powder coated aluminium
polypropylene rope

CUSHIONS

- seat 12 cm quick dry foam + deco 1x (60x60), 2x (40x40)
- seat 12 cm quick dry foam +back polyester fibre filling and deco 1x (35x50)

COLOURS

FOSSIL GREY **DUNE WHITE**

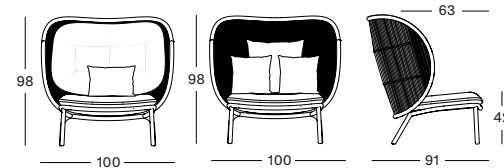

KODO LOUNGE SOFA

MATERIALS
powder coated aluminium
polypropylene rope

CUSHIONS
seat 12 cm quick dry foam
deco 2x (50x50), 3x (40x40)

COLOURS

FOSSIL GREY **DUNE WHITE**

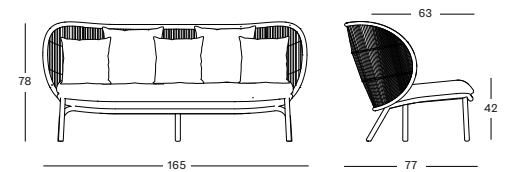

KODO LOUNGE CHAIR

MATERIALS
powder coated aluminium
polypropylene rope

CUSHIONS
seat 12 cm quick dry foam
deco 1x (50x50), 1x (40x40)

COLOURS

FOSSIL GREY **DUNE WHITE**

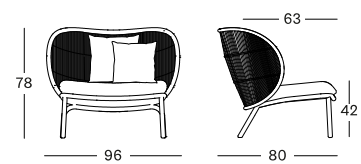

KODO DAYBED

MATERIALS
powder coated aluminium
polypropylene rope

CUSHIONS
seat 12 cm quick dry foam
deco 2x (60x60), 3x (50x50), 2x (40x40)

COLOURS

FOSSIL GREY **DUNE WHITE**

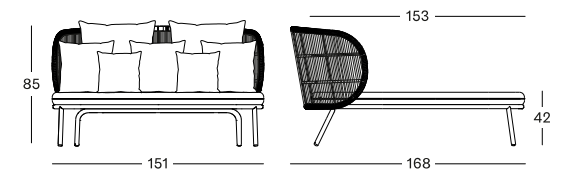

KODO ROCKING CHAIR

MATERIALS
powder coated aluminium and teak slats
polypropylene rope

CUSHIONS

- seat 12 cm quick dry foam + deco 1x (60 x 60), 2x (40 x 40)
- seat 12 cm quick dry foam + back polyester fibre filling and deco 1x (35x50)

COLOURS

FOSSIL GREY **DUNE WHITE**

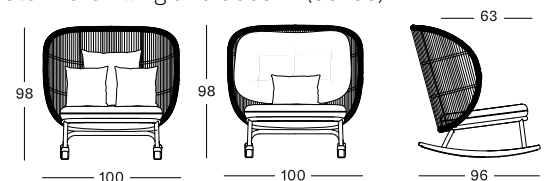

KODO DINING TABLE

MATERIALS
powder coated aluminium
ceramic top

DIMENSIONS
210 x 100 cm
280 x 106 cm

COLOURS

FOSSIL GREY FLINT **DUNE WHITE SHARDS** **DUNE WHITE PORTLAND**

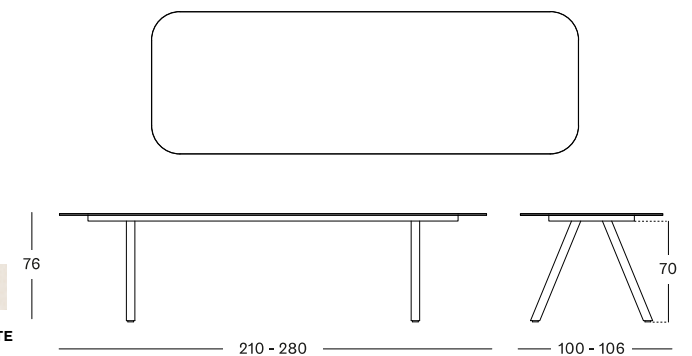



KODO MODULAR 1 SEATER RIGHT

MATERIALS

powder coated aluminium
polypropylene rope

CUSHION

seat 14 cm quick dry foam
back polyester fibre filling

COLOUR



DUNE WHITE

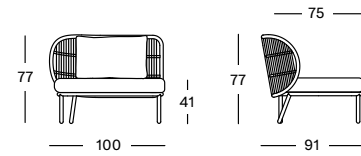

KODO MODULAR 1 SEATER LEFT

MATERIALS

powder coated aluminium
polypropylene rope

CUSHION

seat 14 cm quick dry foam
back polyester fibre filling

COLOUR



DUNE WHITE

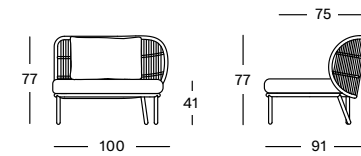

KODO MODULAR 2 SEATER RIGHT

MATERIALS

powder coated aluminium
polypropylene rope

CUSHIONS

seat 14 cm quick dry foam
back polyester fibre filling

COLOUR



DUNE WHITE

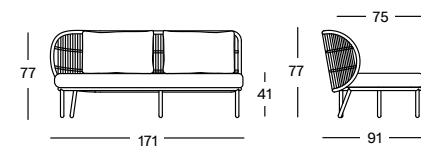

KODO MODULAR 2 SEATER LEFT

MATERIALS

powder coated aluminium
polypropylene rope

CUSHIONS

seat 14 cm quick dry foam
back polyester fibre filling

COLOUR



DUNE WHITE

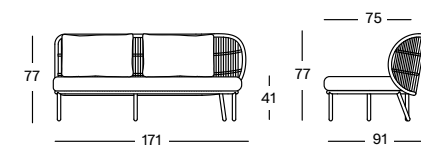

KODO MODULAR CHAISE LONGUE RIGHT

MATERIALS

powder coated aluminium
polypropylene rope

CUSHION

seat 14 cm quick dry foam
back polyester fibre filling

COLOUR



DUNE WHITE

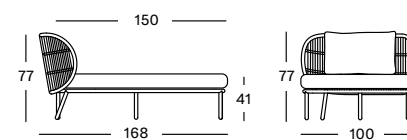

KODO MODULAR CHAISE LONGUE LEFT

MATERIALS

powder coated aluminium
polypropylene rope

CUSHION

seat 14 cm quick dry foam
back polyester fibre filling

COLOUR



DUNE WHITE

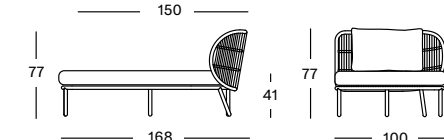

KODO MODULAR CENTER

MATERIALS

powder coated aluminium
polypropylene rope

CUSHIONS

seat 14 cm quick dry foam
back polyester fibre filling

COLOUR



DUNE WHITE

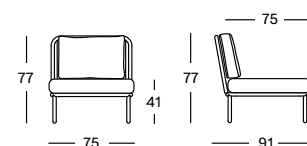

KODO MODULAR CORNER

MATERIALS

powder coated aluminium
polypropylene rope

CUSHIONS

seat 14 cm quick dry foam
back polyester fibre filling

COLOUR



DUNE WHITE

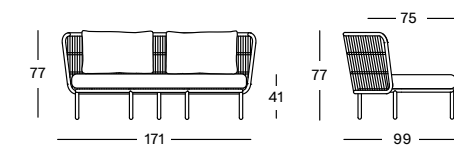



KODO DEEP SOFA

MATERIALS

powder coated aluminium
polypropylene rope

CUSHIONS

seat 14 cm quick dry foam
back polyester fibre filling

COLOURS



FOSSIL GREY DUNE WHITE

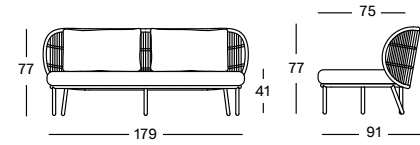

KODO MODULAR OTTOMAN

MATERIALS

powder coated aluminium

CUSHIONS

seat 14 cm quick dry foam

COLOUR



DUNE WHITE

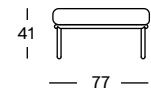

KODO MODULAR CONNECTING SIDE TABLE

MATERIALS

powder coated aluminium

DIMENSIONS

75 x 75 cm
75 x 59 cm

COLOUR



DUNE WHITE

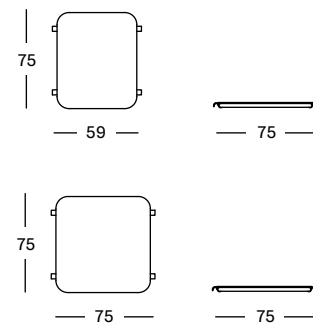

KODO ROUND SIDE TABLE

MATERIALS

- powder coated aluminium with aluminium top
- powder coated aluminium with ceramic top

DIMENSIONS

44 cm H x Ø 40 cm

COLOURS

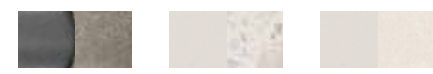

FOSSIL GREY FLINT CERAMIC DUNE WHITE SHARDS CERAMIC DUNE WHITE PORTLAND CERAMIC

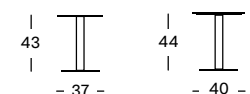

KODO ROUND COFFEE TABLE DIA 68 & DIA 90

MATERIALS

- powder coated aluminium with aluminium top
- powder coated aluminium with ceramic top

DIMENSIONS

36 cm H x Ø 68 cm
30 cm H x Ø 90 cm

COLOURS



FOSSIL GREY FLINT CERAMIC DUNE WHITE SHARDS CERAMIC DUNE WHITE PORTLAND CERAMIC

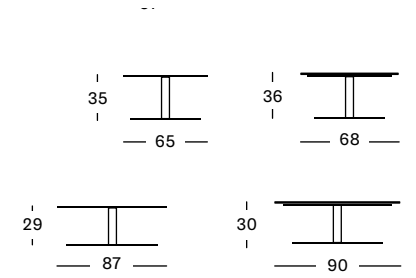

KODO COFFEE TABLE

MATERIALS

- powder coated aluminium with aluminium top
- powder coated aluminium with ceramic top

DIMENSIONS

129 x 45 cm

COLOURS



FOSSIL GREY FLINT CERAMIC DUNE WHITE SHARDS CERAMIC DUNE WHITE PORTLAND CERAMIC

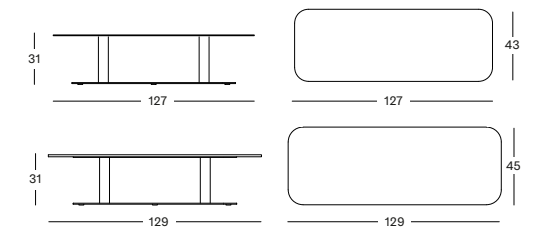

KODO SIDE TABLE

MATERIALS

- powder coated aluminium with aluminium top
- powder coated aluminium with ceramic top

DIMENSIONS

41 x 41 cm

COLOURS



FOSSIL GREY FLINT CERAMIC DUNE WHITE SHARDS CERAMIC DUNE WHITE PORTLAND CERAMIC

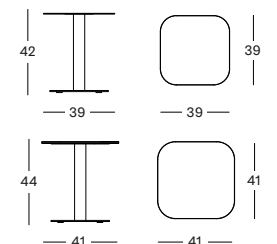

KODO SUNLOUNGER

MATERIALS

powder coated aluminium
polypropylene fibre

CUSHIONS

3 cm polyether foam filling

COLOURS

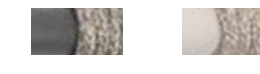

FOSSIL GREY DUNE WHITE

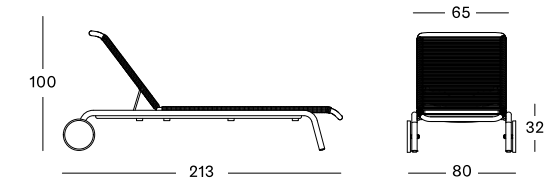

LENTO

Prominently featured solid teak legs and high woven rope backs give the collection a rich and engaging personality. Designed by Bertrand Lejoly



LOUNGE CHAIR - LOUNGE SOFA - MODULAR SOFA
MODULAR CHAISE LONGUE- COFFEE TABLE - SIDE TABLE



LENTO LOUNGE CHAIR, MODULAR SOFA AND COFFEE TABLES



LENTO LOUNGE SOFA 2,5S
COFFEE AND SIDE TABLES

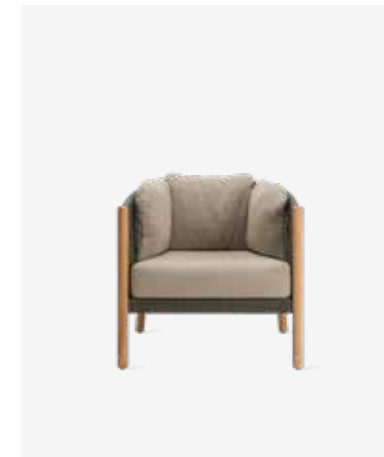

LENTO LOUNGE CHAIR

MATERIALS

untreated teak
polypropylene rope

CUSHIONS

seat 12 cm quick dry foam

- back polyester fibre filling
- deco 1 x (50 x 50), 1 x (40 x 40)

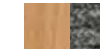

UNTREATED TEAK
ANTHRACITE ROPE

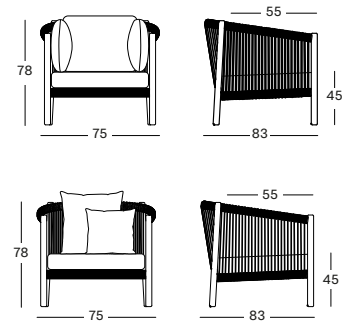

LENTO LOUNGE SOFA 2.5S

MATERIALS

untreated teak
polypropylene rope

CUSHIONS

seat 12 cm quick dry foam
back polyester fibre filling

COLOUR



UNTREATED TEAK
ANTHRACITE ROPE

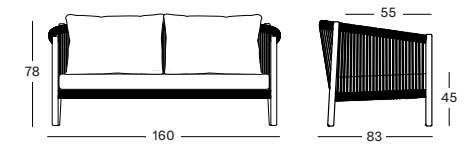

LENTO LOUNGE SOFA 3S

MATERIALS

untreated teak
polypropylene rope

CUSHIONS

seat 12 cm quick dry foam
back polyester fibre filling

COLOUR



UNTREATED TEAK
ANTHRACITE ROPE

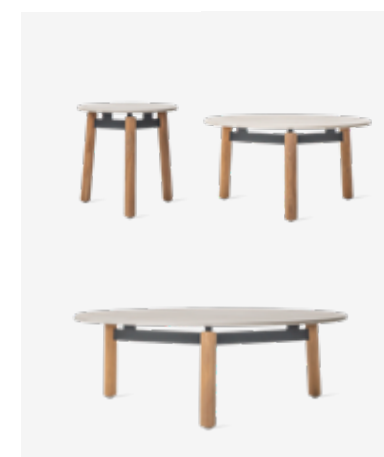
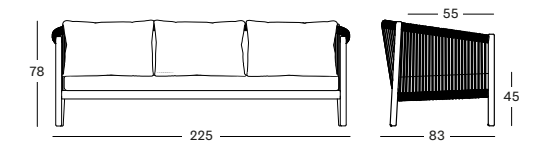

LENTO COFFEE AND SIDE TABLES

MATERIALS

untreated teak and aluminium frame
ceramic top

DIMENSIONS

44 cm H x Ø 45 cm
34 cm H x Ø 68 cm
29 cm H x Ø 90 cm



UNTREATED TEAK
PORTLAND CERAMIC

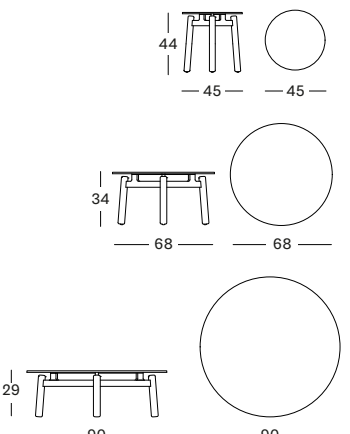



LENTO MODULAR CORNER RIGHT

MATERIALS
untreated teak
polypropylene rope

CUSHIONS
seat 12 cm quick dry foam
back polyester fibre filling

COLOUR

UNTREATED TEAK
ANTHRACITE ROPE

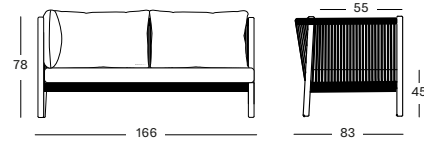

LENTO MODULAR CHAISE LONGUE LEFT

MATERIALS
untreated teak
polypropylene rope

CUSHIONS
seat 12 cm quick dry foam
back polyester fibre filling

COLOUR

UNTREATED TEAK
ANTHRACITE ROPE

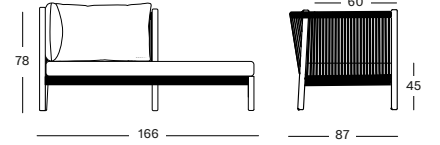

LENTO MODULAR CORNER LEFT

MATERIALS
untreated teak
polypropylene rope

CUSHIONS
seat 12 cm quick dry foam
back polyester fibre filling

COLOUR

UNTREATED TEAK
ANTHRACITE ROPE

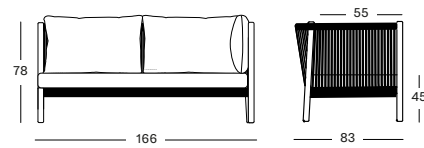

LENTO MODULAR CHAISE LONGUE RIGHT

MATERIALS
untreated teak
polypropylene rope

CUSHIONS
seat 12 cm quick dry foam
back polyester fibre filling

COLOUR

UNTREATED TEAK
ANTHRACITE ROPE

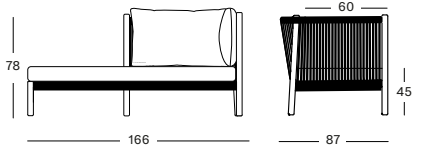

LENTO MODULAR CONNECTING SIDE TABLE

MATERIALS
polypropylene rope
ceramic top

DIMENSIONS
69 x 37 cm

COLOUR

PORTLAND CERAMIC
ANTHRACITE ROPE

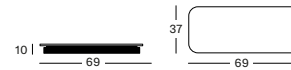

LENTO MODULAR OTTOMAN

MATERIALS
untreated teak
polypropylene rope

CUSHIONS
seat 12 cm quick dry foam

COLOUR

UNTREATED TEAK
ANTHRACITE ROPE

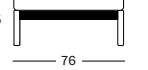

CLEO

A stylish blend of lightweight aluminum and comfortable woven rope for your outdoor spaces.



LOUNGE CHAIR - LOUNGE SOFA



CLEO LOUNGE CHAIR AND SOFA dune white
LILO COFFEE AND SIDE TABLE dune white



CLEO DINING CHAIR dune white
MATTEO DINING TABLE



CLEO DINING CHAIR dune white
KODO DINING TABLE dune white | ceramic portland



CLEO DINING ARMCHAIR

MATERIALS
polypropylene rope
powder coated aluminium frame

CUSHIONS
2 cm polyether foam

COLOUR



DUNE WHITE/
DUNE WHITE FOSSIL GREY/
MISTY DOTS SAGE GREEN/
MISTY DOTS

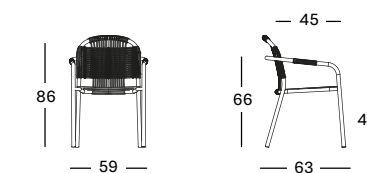

CLEO LOUNGE CHAIR

MATERIALS
polypropylene rope
powder coated aluminium frame

CUSHIONS
3 cm quick dry foam

COLOUR



DUNE WHITE/
DUNE WHITE FOSSIL GREY/
MISTY DOTS SAGE GREEN/
MISTY DOTS

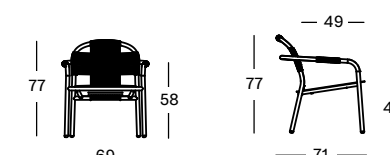

CLEO LOUNGE SOFA

MATERIALS
polypropylene rope
powder coated aluminium frame

CUSHIONS
3 cm quick dry foam

COLOUR



DUNE WHITE/
DUNE WHITE FOSSIL GREY/
MISTY DOTS SAGE GREEN/
MISTY DOTS

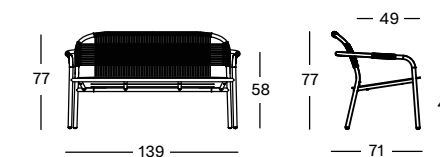

LILO COFFEE & SIDE TABLES

MATERIALS
powder coated aluminium frame

DIMENSIONS
44 cm H x Ø 45 cm
36 cm H x Ø 60 cm
30 cm H x Ø 68 cm

COLOUR



DUNE
WHITE FOSSIL
GREY SAGE
GREEN

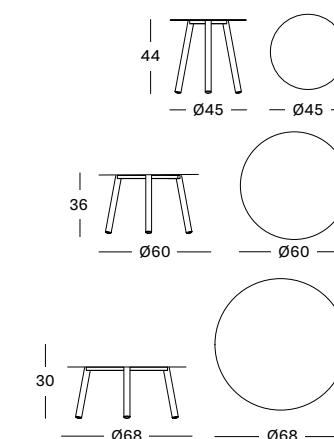

FREYA MONA NOA REMI VOLTA

Renowned for its resilience and timeless beauty, teak has the power to transform any space into a sanctuary of elegance.







REMI DINING CHAIR fossil grey
NOA DINING TABLE



MONA DINING CHAIR old lace





VOLTA DINING TABLE

MATERIALS

ceramic top
untreated teak frame

DIMENSIONS

240 x 100 cm
310 x 100 cm

COLOUR



UNTREATED TEAK
MASAI BLANCO CERAMIC

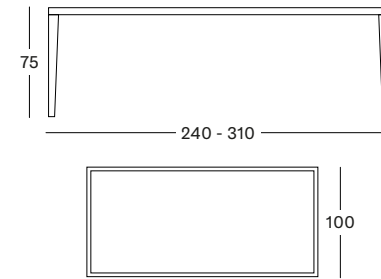

MONA DINING CHAIR TEAK

MATERIALS

polyethylene wicker seat
untreated teak base

CUSHIONS

2 cm polyether foam

COLOUR



UNTREATED TEAK
OLD LACE WICKER

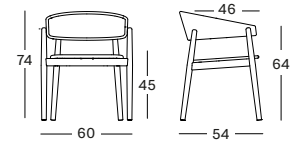

SAM DINING TABLE

MATERIALS

untreated solid teak

DIMENSIONS

75 cm H x Ø 120 cm

COLOUR



UNTREATED TEAK

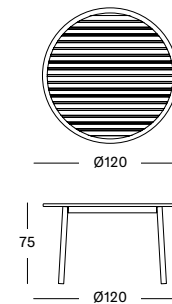

MONA DINING CHAIR BLACK STAINED BRUSHED TEAK

MATERIALS

polyethylene wicker seat
brushed teak base

CUSHIONS

2 cm polyether foam

COLOUR



BLACK BRUSHED TEAK
BLACK WICKER

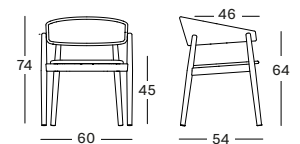

NOA DINING TABLE

MATERIALS

untreated solid teak
powder coated aluminium connection

DIMENSIONS

75 cm H x Ø 90 cm
75 cm H x Ø 132 cm
75 cm H x Ø 150 cm

COLOUR



UNTREATED TEAK

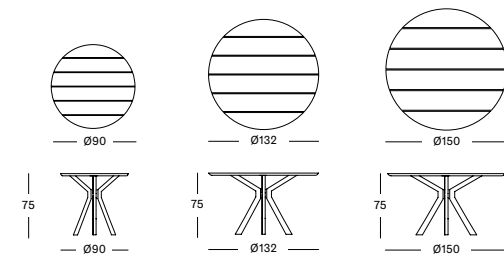

REMI DINING CHAIR TEAK BASE

MATERIALS

aluminium and polypropylene rope seat
teak base

CUSHIONS

2 cm polyether foam

COLOURS



UNTREATED TEAK
FOSSIL GREY UNTREATED TEAK
DUNE WHITE

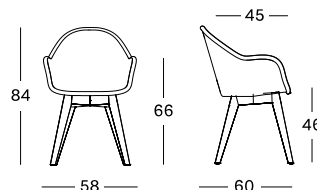

FREYA DINING ARMCHAIR

MATERIALS

untreated solid teak

CUSHION

seat 2 cm polyether foam

COLOUR



UNTREATED TEAK

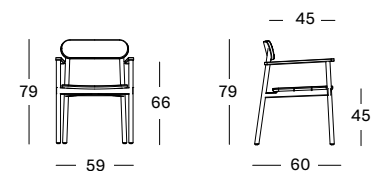

REMI DINING CHAIR STEEL A BASE

MATERIALS

aluminium and polypropylene rope seat
black epoxy coated steel base

CUSHIONS

2 cm polyether foam

COLOURS



BLACK STEEL
FOSSIL GREY BLACK STEEL
DUNE WHITE

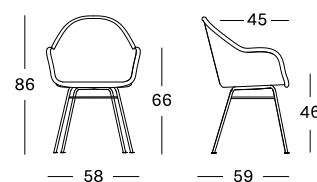

LEO

The comfortable seating of the tub chair, the laid-back shape of the sofa, and the playful weaving turn it into a real eye catcher.



LOUNGE CHAIR - LOUNGE SOFA - MODULAR SOFA
SIDE TABLE - COFFEE TABLE - DINING CHAIR - DINING TABLE



LEO LOUNGE CHAIR, MODULAR SOFA AND COFFEE TABLES
TOUNDRA RUG sahara



LEFT PAGE: LEO DINING CHAIR AND DINING TABLE
RIGHT PAGE: LEO LOUNGE CHAIR, SOFA AND COFFEE TABLES





LEO MODULAR CORNER LEFT

MATERIALS

powder coated aluminium
acrylic rope

CUSHIONS

seat 12 cm quick dry foam
back polyester fibre filling + deco 1x (50x50), 1x (40x40)

COLOUR



LAVA ALUMINIUM
LAVA ROPE

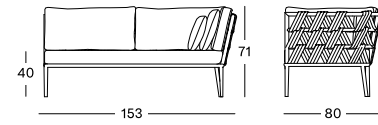

LEO LOUNGE CHAIR

MATERIALS

powder coated aluminium
acrylic rope

CUSHIONS

seat 12 cm quick dry foam
back polyester fibre filling

COLOUR



LAVA ALUMINIUM
LAVA ROPE

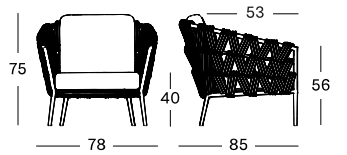

LEO MODULAR CORNER RIGHT

MATERIALS

powder coated aluminium
acrylic rope

CUSHIONS

seat 12 cm quick dry foam
back polyester fibre filling + deco 1x (50x50), 1x (40x40)

COLOUR



LAVA ALUMINIUM
LAVA ROPE

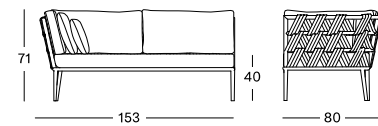

LEO LOUNGE SOFA

MATERIALS

powder coated aluminium
acrylic rope

CUSHIONS

seat 12 cm quick dry foam
back polyester fibre filling

COLOUR

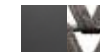

LAVA ALUMINIUM
LAVA ROPE

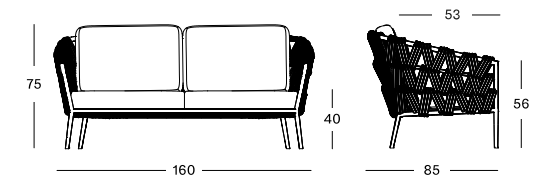

LEO MODULAR CENTER

MATERIALS

powder coated aluminium
acrylic rope

CUSHIONS

seat 12 cm quick dry foam
back polyester fibre filling

COLOUR



LAVA ALUMINIUM
LAVA ROPE

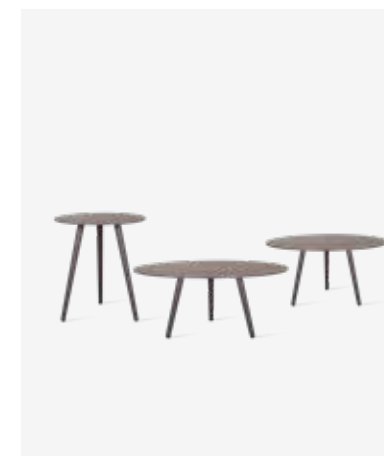
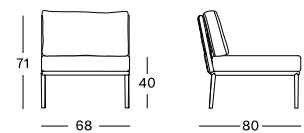

LEO COFFEE AND SIDE TABLES

MATERIALS

powder coated aluminium

DIMENSIONS

48 cm H x Ø 45 cm
32 cm H x Ø 60 cm
38 cm H x Ø 70 cm

COLOUR

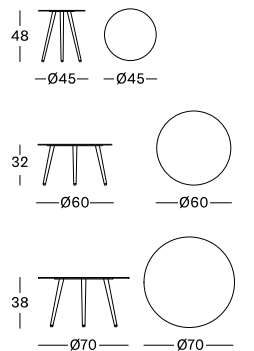

LEO MODULAR FOOTREST

MATERIALS

powder coated aluminium

CUSHION

seat 12 cm quick dry foam

COLOUR



LAVA ALUMINIUM

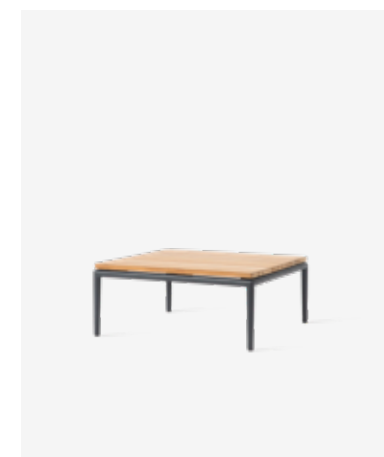
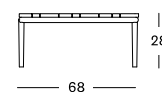

LEO MODULAR COFFEE TABLE

MATERIALS

powder coated aluminium
untreated teak

DIMENSIONS

68 x 68 cm

COLOUR



LAVA ALUMINIUM
UNTREATED TEAK

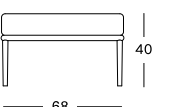



LEO DINING CHAIR

MATERIALS
powder coated aluminium
acrylic rope

CUSHIONS
seat 4 cm quick dry foam
back polyester fibre filling

COLOUR

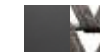

LAVA ALUMINIUM

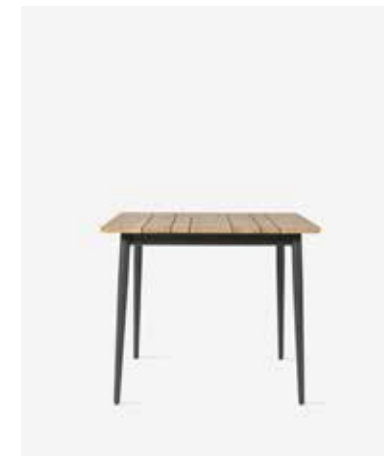
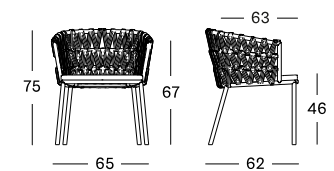

LEO DINING TABLE 90x90

MATERIALS
powder coated aluminium
untreated teak top

DIMENSIONS
90 x 90 cm

COLOUR



LAVA ALUMINIUM
UNTREATED TEAK

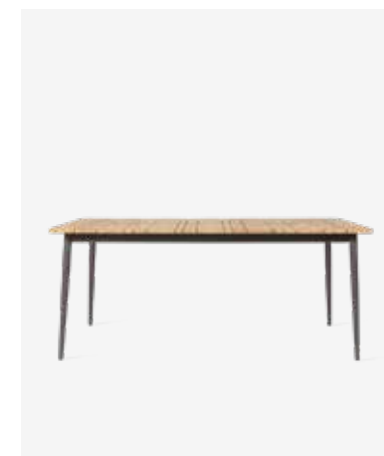
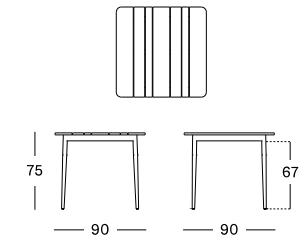

LEO DINING TABLE

MATERIALS
powder coated aluminium
untreated teak top

DIMENSIONS
180 x 90 cm
240 x 100 cm

COLOUR



LAVA ALUMINIUM
UNTREATED TEAK

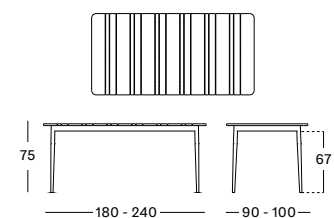

MAX DINING TABLE

MATERIALS
powder coated aluminium frame
untreated teak top or black hpl top (90x90)

DIMENSIONS
90 x 90 cm (top also available in hpl)
180 x 90 cm
240 x 100 cm



BLACK/
UNTREATED TEAK



BLACK/HPL



FOSSIL GREY/
UNTREATED TEAK

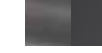

FOSSIL GREY/
HPL



DUNE WHITE/
UNTREATED TEAK



DUNE WHITE/
HPL

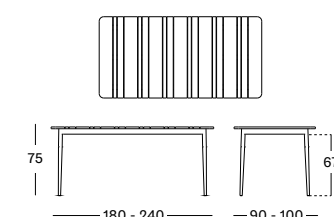
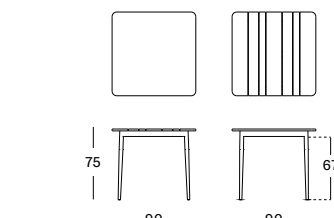



TOUNDRA OUTDOOR RUG

MATERIALS
polyester fibre

DIMENSIONS
170 x 240 cm
200 x 300 cm
250 x 350 cm

COLOURS

SAHARA



CLIFF OUTDOOR RUG

MATERIALS
polyester fibre

DIMENSIONS
170 x 240 cm
200 x 300 cm
250 x 350 cm

COLOURS

CLAY



CLIFF RUG AND ROZY COFFEE TABLE

DAVID

David's woven back and rope details in a soft earthy tone match perfectly with the solid teak frame and add a sense of tactility.



LOUNGE CHAIR - LOUNGE SOFA - COFFEE TABLE - SIDE TABLE
DINING CHAIR - DINING TABLE - SUNLOUNGER



DAVID LOUNGE SOFA 2S, LOUNGE CHAIR, COFFEE AND SIDE TABLE
TOUNDRA RUG sahara



LEFT PAGE: DAVID DINING CHAIR AND DINING TABLE
RIGHT PAGE: DAVID SUNLOUNGER





DAVID DINING ARMCHAIR

MATERIALS
stained brushed teak
polypropylene rope

CUSHION
4 cm quick dry foam

COLOUR



AGED TEAK

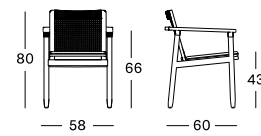

DAVID LOUNGE CHAIR

MATERIALS
stained brushed teak
polypropylene rope

CUSHIONS
seat 12 cm quick dry foam
back polyester fibre filling

COLOUR



AGED TEAK

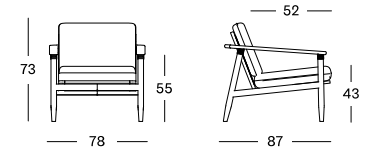

DAVID DINING TABLE

MATERIALS
stained brushed teak
ceramic top

DIMENSIONS
210 x 100 cm
280 x 106 cm

COLOUR



AGED TEAK
FLINT CERAMIC

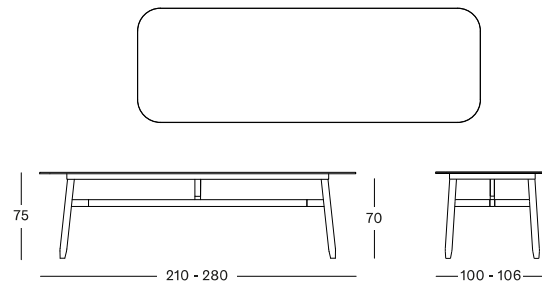

DAVID LOUNGE SOFA 2S

MATERIALS
stained brushed teak
polypropylene rope

CUSHIONS
seat 12 cm quick dry foam
back polyester fibre filling

COLOUR



AGED TEAK

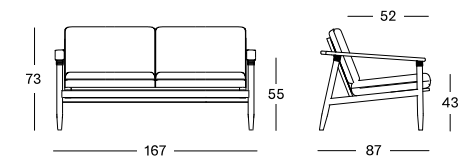

DAVID SUNLOUNGER

MATERIALS
stained brushed teak
polypropylene rope

CUSHION
6 cm quick dry foam

COLOUR



AGED TEAK



DAVID LOUNGE SOFA 3S

MATERIALS
stained brushed teak
polypropylene rope

CUSHIONS
seat 12 cm quick dry foam
back polyester fibre filling

COLOUR



AGED TEAK

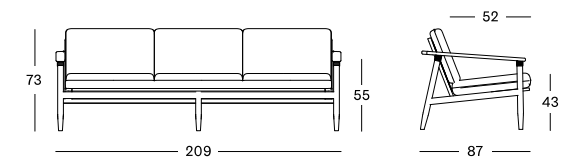

DAVID ROUND COFFEE & SIDE TABLE

MATERIALS
stained brushed teak
ceramic top

DIMENSIONS
side table: 40 cm H x Ø 40 cm
coffee table: 34 cm H x Ø 68 cm

COLOUR



AGED TEAK
FLINT CERAMIC

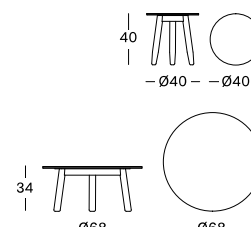

DAVID COFFEE AND SIDE TABLES

MATERIALS
stained brushed teak
ceramic top

DIMENSIONS
side table: 41 x 41 cm
coffee table: 120 x 120 cm
coffee table: 129 x 45 cm

COLOUR



AGED TEAK
FLINT CERAMIC

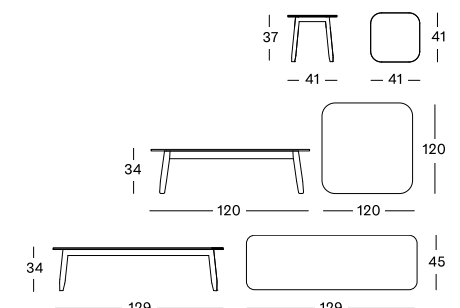

LOOP

Through its slim profile and see-through weave, which balances utter comfort with ample spatiality, the Loop collection is a symbol of attractive yet functional design.



SOFA - LOUNGE CHAIR - FOOTREST - SUNLOUNGER
SIDE TABLE - COFFEE TABLE - DINING CHAIR



LEFT PAGE: LOOP LOUNGE CHAIR AND LILO SIDE TABLE dune white
RIGHT PAGE: LOOP DINING CHAIR moss





LOOP SOFA, LOUNGE CHAIR, COFFEE AND SIDE TABLE fossil grey



LOOP FOOTREST

MATERIALS

- powder coated aluminium
- polyethylene fibre (black)
- polypropylene rope (other colours)

COLOURS



BLACK DUNE WHITE TAUPE



MOSS TERRACOTTA FOSSIL GREY

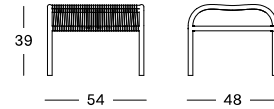

LOOP SIDE TABLE

MATERIALS

- powder coated aluminium
- polyethylene fibre (black)
- polypropylene rope (other colours)

COLOURS



BLACK DUNE WHITE TAUPE



MOSS TERRACOTTA FOSSIL GREY

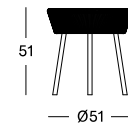

LOOP COFFEE TABLE

MATERIALS

- powder coated aluminium
- polyethylene fibre (black)
- polypropylene rope (other colours)

COLOURS



BLACK DUNE WHITE

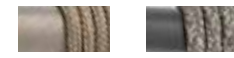

TAUPE FOSSIL GREY

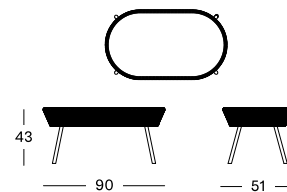

LOOP DINING CHAIR

MATERIALS

- powder coated aluminium
- polyethylene fibre (black)
- polypropylene rope (other colours)

COLOURS



BLACK DUNE WHITE TAUPE



MOSS TERRACOTTA FOSSIL GREY

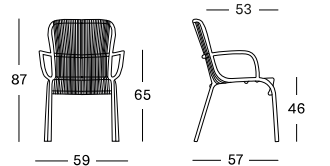

LOOP LOUNGE CHAIR

MATERIALS

- powder coated aluminium
- polyethylene fibre (black)
- polypropylene rope (other colours)

COLOURS



BLACK DUNE WHITE TAUPE



MOSS TERRACOTTA FOSSIL GREY

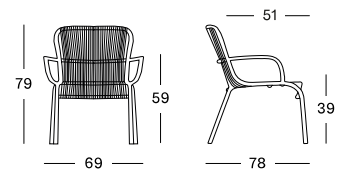

LOOP SOFA

MATERIALS

- powder coated aluminium
- polyethylene fibre (black)
- polypropylene rope (other colours)

COLOURS



BLACK DUNE WHITE



TAUPE FOSSIL GREY

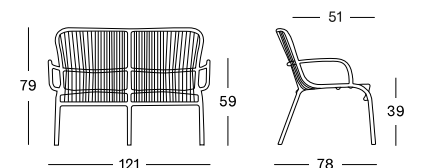

LOOP SUNLOUNGER

MATERIALS

- powder coated aluminium
- polyethylene fibre (black)
- polypropylene rope (other colours)

CUSHIONS

3 cm polyether foam

COLOURS



BLACK DUNE WHITE TAUPE FOSSIL GREY

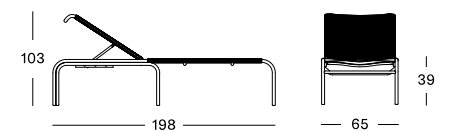

LIGHTING

Extend the evenings and illuminate your outdoor experience with stunning lighting designs.



MAYA - TIKA - MORA - LIGHT MY TABLE



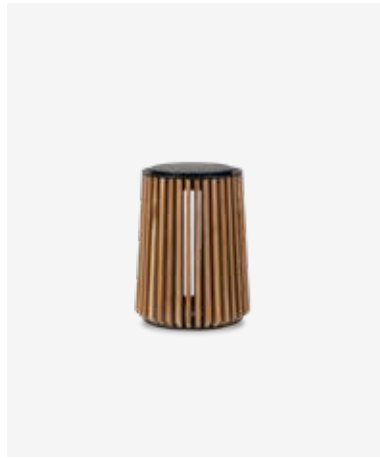

MAYA LAMP SMALL

MATERIALS

repurposed teak slats
casted aluminium frame
solar-powered LED module

DIMENSIONS

34 cm H x Ø 27 cm

COLOUR



UNTREATED TEAK
BLACK ALUMINIUM

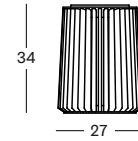

MAYA LAMP LARGE

MATERIALS

repurposed teak slats
casted aluminium frame
solar-powered LED module

DIMENSIONS

48 cm H x Ø 28 cm

COLOUR



UNTREATED TEAK
BLACK ALUMINIUM

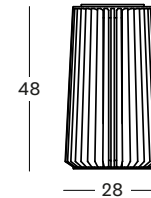

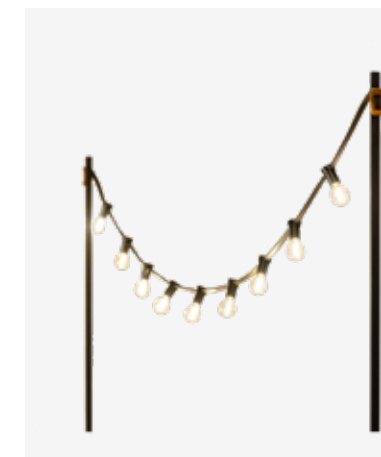
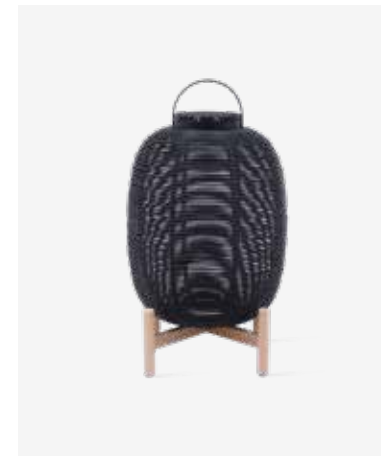
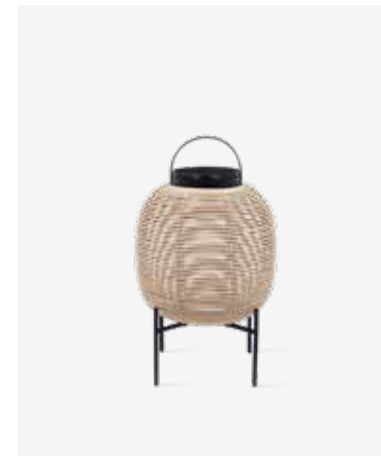
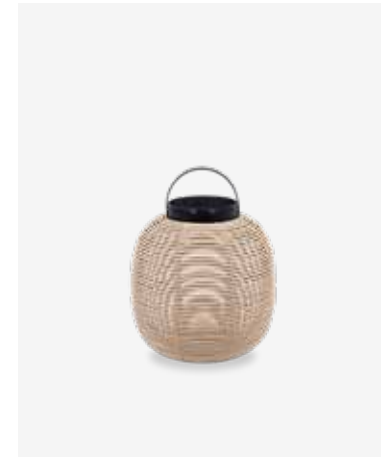

TIKA LANTERN

MATERIALS

powder coated aluminium with HDPE wicker
solar-powered LED module

DIMENSIONS

40 cm H x Ø 35 cm
59 cm H x Ø 47 cm

COLOURS



CAMEL



BLACK

TIKA LANTERN STEEL BASE

MATERIALS

powder coated aluminium with HDPE wicker
solar-powered LED module
powder coated steel base

DIMENSIONS

59 cm H x Ø 35 cm
69 cm H x Ø 47 cm

COLOURS

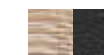

CAMEL / BLACK



BLACK / BLACK

TIKA LANTERN TEAK BASE

MATERIALS

powder coated aluminium with HDPE wicker
solar-powered LED module
untreated teak base

DIMENSIONS

59 cm H x Ø 35 cm
69 cm H x Ø 47 cm

COLOUR

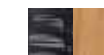

BLACK / UNTREATED TEAK

LIGHT MY TABLE

MATERIALS

black powder coated
galvanized steel
leather details
9 LED lamps 2W

DIMENSIONS

adjustable 200 – 300 cm
(for table tops up to 6 cm thick)

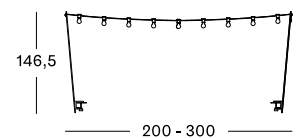
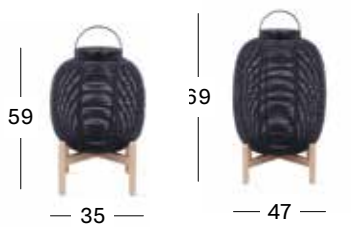
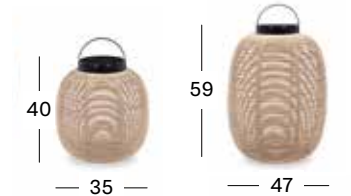



MORA LAMP WITH HANDLE 54 CM H

MATERIALS

powder coated steel
polypropylene rope
solar-powered LED module

DIMENSIONS

54 cm H x Ø 26 cm

COLOUR



FOSSIL GREY ROPE

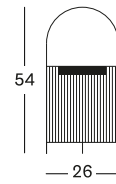

MORA LAMP 42 CM H X 54 CM DIA

MATERIALS

powder coated steel
polypropylene rope
solar-powered LED module

DIMENSIONS

42 cm H x Ø 54 cm

COLOUR



FOSSIL GREY ROPE

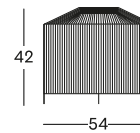

MORA LAMP 61 CM H X 40 CM DIA

MATERIALS

powder coated steel
polypropylene rope
solar-powered LED module

DIMENSIONS

61 cm H x Ø 40 cm

COLOUR



FOSSIL GREY ROPE

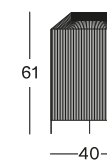

ROY

The Roy collection combines nostalgic design with innovative materials, giving your outdoor space a strong graphic twist.



LAZY CHAIR - COCOON - DINING CHAIR



LEFT PAGE: ROXY DINING CHAIR black, RONDA BISTRO TABLE AND MAYA LAMP SMALL
RIGHT PAGE: ROXANNE DINING CHAIR black AND RONDA BISTRO TABLE





LEFT PAGE: ROY COCOON black
RIGHT PAGE: ROY LAZY CHAIR camel



SPHERA BISTRO TABLE

MATERIALS

black epoxy coated steel base
untreated teak or black hpl top

DIMENSIONS

Ø 80 cm

COLOURS



UNTREATED TEAK BLACK HPL

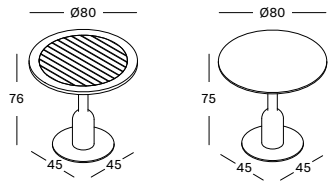

ROXANNE DINING CHAIR

MATERIALS

aluminium and polyethylene wicker seat
black epoxy coated steel base

CUSHIONS

seat 2 cm polyether foam

COLOURS



CAMEL WICKER BLACK WICKER

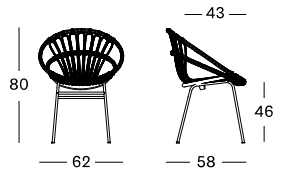

RONDA BISTRO TABLE

MATERIALS

black epoxy coated steel base
untreated teak top or black HPL top

DIMENSIONS

Ø 110 cm

COLOURS



UNTREATED TEAK BLACK HPL

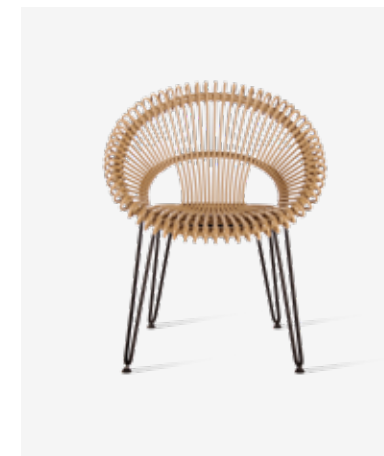
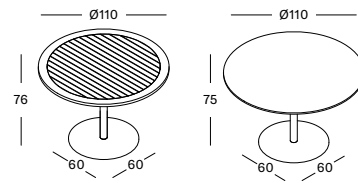

ROXY DINING CHAIR

MATERIALS

aluminium and polyethylene wicker seat
black epoxy coated steel base

CUSHIONS

seat 2 cm polyether foam

COLOURS



CAMEL WICKER BLACK WICKER

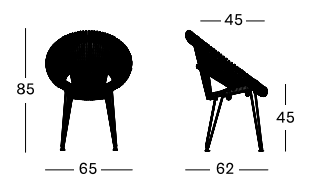

QUADRO BISTRO TABLE

MATERIALS

black powder coated steel base
untreated teak or hpl top

DIMENSIONS

70 x 70 cm

COLOURS



UNTREATED TEAK BLACK HPL

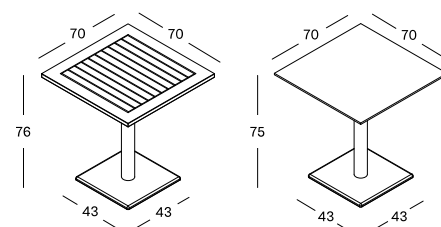

ROY LAZY CHAIR

MATERIALS

aluminium and polyethylene wicker seat
black epoxy coated steel base

CUSHIONS

seat 2 cm polyether foam

COLOURS



CAMEL WICKER BLACK WICKER

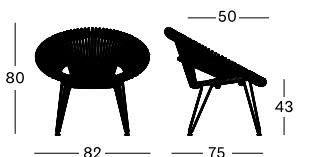

MAX DINING TABLE

MATERIALS

powder coated aluminium frame
untreated teak top or black hpl top (90x90)

DIMENSIONS

90 x 90 cm (also available in hpl)

180 x 90 cm

240 x 100 cm



BLACK/UNTREATED TEAK FOSSIL GREY/UNTREATED TEAK DUNE WHITE/UNTREATED TEAK



BLACK/HPL FOSSIL GREY/HPL DUNE WHITE/HPL

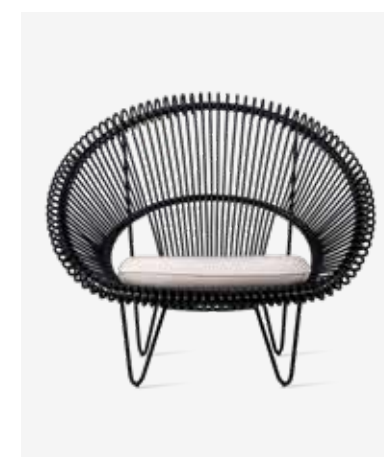
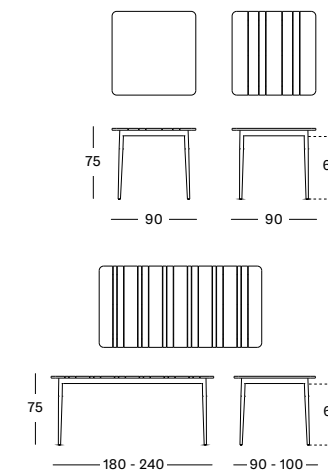

ROY COCOON

MATERIALS

aluminium and polyethylene wicker seat
black epoxy coated steel base

CUSHIONS

seat 8 cm quick dry foam

COLOURS



CAMEL WICKER BLACK WICKER

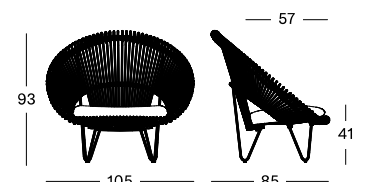



ROZY SIDE TABLE

MATERIALS
epoxy coated steel
black hpl

DIMENSIONS
50 x 49 x 42 cm

COLOUR
■
BLACK HPL

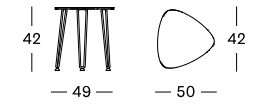

ROZY COFFEE TABLE

MATERIALS
epoxy coated steel
black hpl

DIMENSIONS
99 x 114 x 72 cm

COLOUR
■
BLACK HPL

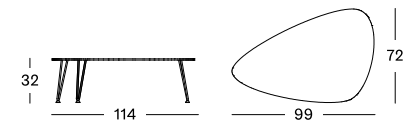

WICKED

By creating an unexpectedly light and airy shape, Belgian designer Alain Gilles managed to shed new light onto the traditional wicker furniture.



LOUNGE CHAIR - LOUNGE SOFA - SIDE TABLE - COFFEE TABLE - DINING CHAIR - DINING TABLE



WICKED LOUNGE SOFA 2S AND LOUNGE CHAIR taupe
COFFEE AND SIDE TABLE



WICKED LOUNGE CHAIR taupe



WICKED DINING CHAIR taupe
WICKED DINING TABLE



WICKED DINING CHAIR

MATERIALS
powder coated aluminium
polyethylene wicker

CUSHIONS
2 cm polyether foam

COLOURS



BLACK
TAUPE

WHITE
NATURAL

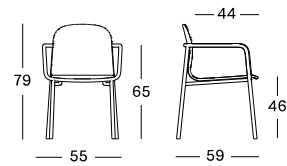

WICKED DINING TABLE

MATERIALS
powder coated aluminium
untreated teak

DIMENSIONS
200 x 90 cm
250 x 90 cm

COLOURS



BLACK ALUMINIUM
UNTREATED TEAK

WHITE ALUMINIUM
UNTREATED TEAK

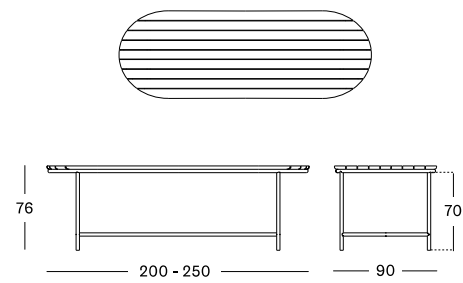

WICKED SIDE TABLE

MATERIALS
powder coated aluminium
untreated teak

DIMENSIONS
Ø 37 cm

COLOURS



BLACK ALUMINIUM
UNTREATED TEAK

WHITE ALUMINIUM
UNTREATED TEAK

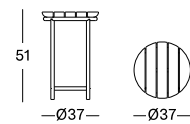

WICKED COFFEE TABLE

MATERIALS
powder coated aluminium
untreated teak

DIMENSIONS
123 x 55 cm

COLOURS



BLACK ALUMINIUM
UNTREATED TEAK

WHITE ALUMINIUM
UNTREATED TEAK

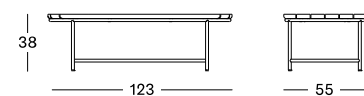

WICKED LOUNGE CHAIR

MATERIALS
powder coated aluminium
polyethylene wicker

CUSHIONS
seat 10 cm quick dry foam
deco 1 x (40x40)

COLOURS



BLACK
TAUPE

WHITE
NATURAL

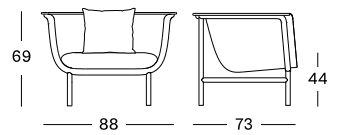

WICKED LOUNGE SOFA 2S

MATERIALS
powder coated aluminium
polyethylene wicker

CUSHIONS
seat 10 cm quick dry foam
deco 2x (45x50), 3x (40x40)

COLOURS



BLACK
TAUPE

WHITE
NATURAL

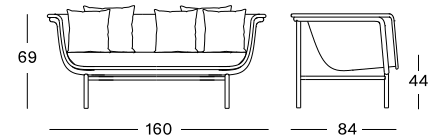

WICKED LOUNGE SOFA 3S

MATERIALS
powder coated aluminium
polyethylene wicker

CUSHIONS
seat 10 cm quick dry foam
deco 3x (45x50), 2x (40x40)

COLOURS



BLACK
TAUPE

WHITE
NATURAL

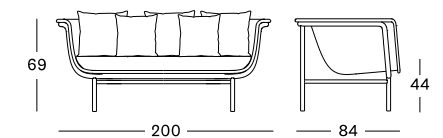

EDGARD LENA GIPSY

Woven wicker furniture 100% fit for outdoor use all year round



DINING CHAIR - BAR STOOL - LOUNGE CHAIR - COCOON





LEFT PAGE: GIPSY DINING CHAIR AND WICKED DINING TABLE
RIGHT PAGE: GIPSY LOUNGE CHAIR AND IVO COFFEE TABLE





EDGARD DINING CHAIR black
MATTEO DINING TABLE AND LIGHT MY TABLE



LENA DINING CHAIR old lace



EDGARD DINING CHAIR TEAK BASE

MATERIALS

aluminium and polyethylene wicker seat
teak base

CUSHIONS

2 cm polyether foam

COLOURS



UNTREATED TEAK
OLD LACE



UNTREATED TEAK
MOCCA



UNTREATED TEAK
BLACK

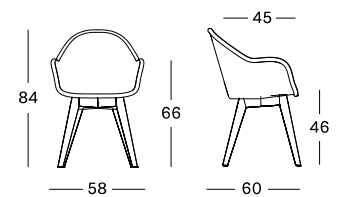

EDGARD DINING CHAIR STEEL A BASE

MATERIALS

aluminium and polyethylene wicker seat
black epoxy coated steel base

CUSHIONS

2 cm polyether foam

COLOURS



BLACK
OLD LACE



BLACK
MOCCA



BLACK
BLACK

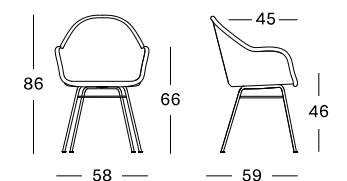

LENA DINING CHAIR TEAK BASE

MATERIALS

aluminium and polyethylene wicker seat
teak base

COLOURS



UNTREATED TEAK
OLD LACE



UNTREATED TEAK
MOCCA



UNTREATED TEAK
BLACK

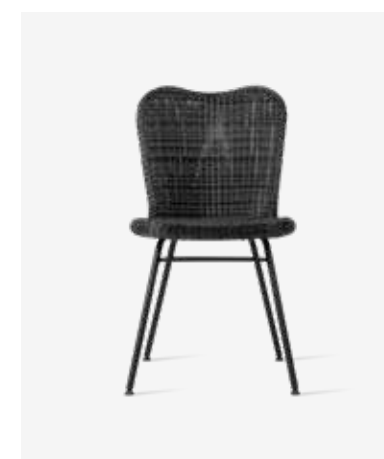
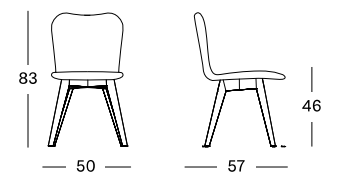

LENA DINING CHAIR STEEL A BASE

MATERIALS

aluminium and polyethylene wicker seat
black epoxy coated steel base

COLOURS



BLACK
OLD LACE



BLACK
MOCCA



BLACK
BLACK

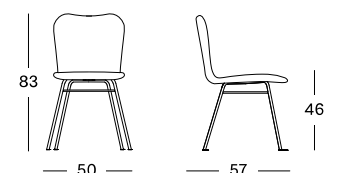



MATTEO DINING TABLE

MATERIALS

powder coated aluminium legs
untreated teak top

DIMENSIONS

215 x 100 cm
285 x 100 cm

COLOURS



BLACK ALUMINIUM
UNTREATED TEAK DUNE WHITE ALUMINIUM
UNTREATED TEAK

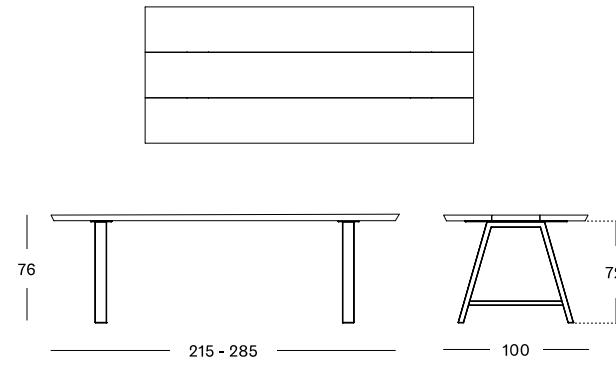

GIPSY DINING CHAIR

MATERIALS

aluminium and polyethylene wicker seat
epoxy and powder coated steel base

CUSHIONS

2 cm polyether foam

COLOUR



BLACK STEEL
BLACK WICKER

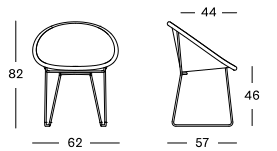

MATTEO BENCH

MATERIALS

powder coated aluminium legs
untreated teak seat

DIMENSIONS

195 x 40 cm
265 x 40 cm

COLOURS



BLACK ALUMINIUM
UNTREATED TEAK DUNE WHITE ALUMINIUM
UNTREATED TEAK

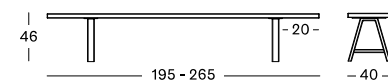

GIPSY COCOON

MATERIALS

aluminium and polyethylene wicker seat
epoxy and black powder coated steel base

CUSHIONS

8 cm quick dry foam

COLOUR



BLACK STEEL
BLACK WICKER

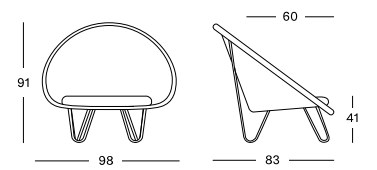

EDGARD BAR STOOL TEAK BASE

MATERIALS

aluminium and polyethylene wicker seat
teak base

COLOURS



UNTREATED TEAK
OLD LACE UNTREATED TEAK
MOCCA UNTREATED TEAK
BLACK

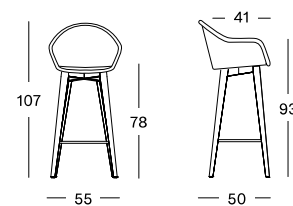

GIPSY LOUNGE

MATERIALS

aluminium and polyethylene wicker seat
epoxy and black powder coated steel base

CUSHIONS

seat 12 cm quick dry foam
back 1 x (60x60) and 2x (40x40)

COLOUR



BLACK STEEL
BLACK WICKER

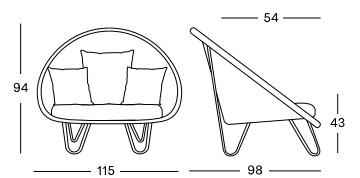

EDGARD BAR STOOL STEEL BASE

MATERIALS

aluminium and polyethylene wicker seat
black epoxy coated steel base

COLOURS



BLACK
OLD LACE BLACK
MOCCA BLACK
BLACK

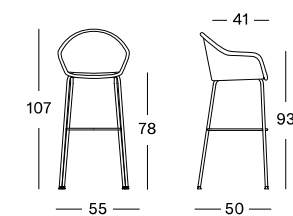



IVO SIDE TABLE DIA 44

MATERIALS

powder coated aluminium
HDPE wicker
hpl

DIMENSIONS

45 cm H x Ø 44 cm

COLOUR



BLACK WICKER
BLACK HPL

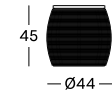

IVO COFFEE TABLE DIA 77

MATERIALS

powder coated aluminium
HDPE wicker
hpl

DIMENSIONS

37 cm H x Ø 77 cm

COLOUR



BLACK WICKER
BLACK HPL

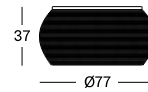

IVO COFFEE TABLE DIA 93

MATERIALS

powder coated aluminium
HDPE wicker
hpl

DIMENSIONS

37 cm H x Ø 93 cm

COLOUR



BLACK WICKER
BLACK HPL

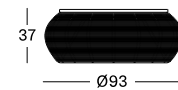

LUCY

Lucy will inject your terrace and garden with charm and comfort. The soft, flowing round shapes of these chairs invite you to relax in the sun.



LAZY ARMCHAIR - LOUNGE CHAIR - FOOTREST - SIDE TABLE - MODULAR SOFA - DINING CHAIR - SUNLOUNGER



LEFT PAGE: LUCY DINING ARMCHAIR off white
RIGHT PAGE: LUCY LOUNGE CHAIR off white







LUCY DINING CHAIR

MATERIALS
powder coated aluminium
polyethylene fibre

CUSHION
seat 2 cm polyether foam

COLOUR

OFF WHITE

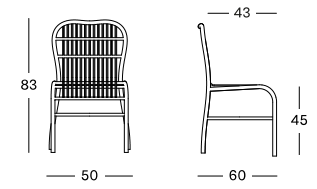

LUCY DINING ARMCHAIR

MATERIALS
powder coated aluminium
polyethylene fibre

CUSHION
seat 2 cm polyether foam

COLOUR

OFF WHITE

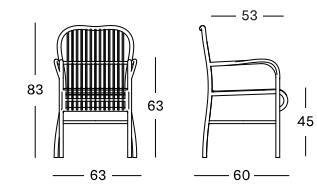

LUCY SUNLOUNGER

MATERIALS
powder coated aluminium
polyethylene fibre

CUSHION
seat 3 cm polyether foam

COLOUR

OFF WHITE

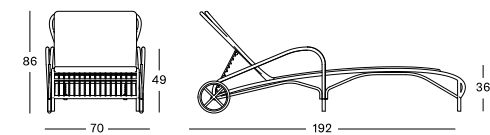



LUCY LAZY ARMCHAIR

MATERIALS
powder coated aluminium
polyethylene fibre

CUSHION
seat 2 cm polyether foam

COLOUR



OFF WHITE

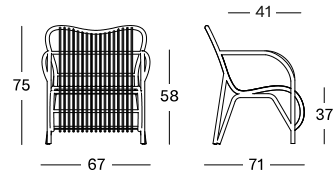

LUCY MODULAR CORNER

MATERIALS
powder coated aluminium
polyethylene fibre

CUSHIONS
seat 12 cm quick dry foam
back polyester fibre

COLOUR



OFF WHITE

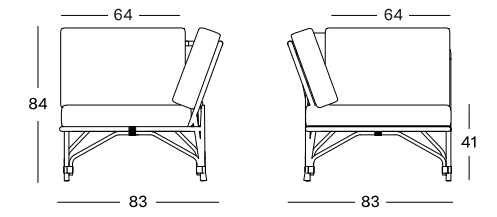

LUCY LOUNGE CHAIR

MATERIALS
powder coated aluminium
polyethylene fibre

COLOUR



OFF WHITE

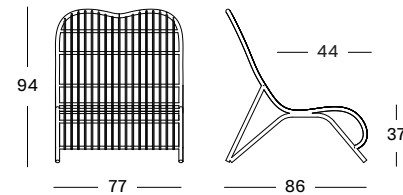

LUCY MODULAR CENTER

MATERIALS
powder coated aluminium
polyethylene fibre

CUSHIONS
seat 12 cm quick dry foam
back polyester fibre

COLOUR



OFF WHITE

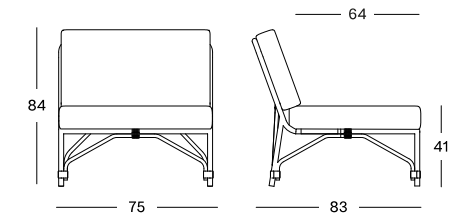

LUCY FOOTREST

MATERIALS
powder coated aluminium
polyethylene fibre

COLOUR



OFF WHITE

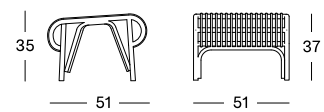

LUCY OTTOMAN

MATERIALS
powder coated aluminium
polyethylene fibre

CUSHIONS
seat 12 cm quick dry foam

COLOUR



OFF WHITE

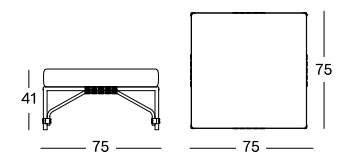

LUCY SIDE TABLE

MATERIALS
powder coated aluminium
polyethylene fibre
glass

DIMENSIONS
46 x 46 cm

COLOUR



OFF WHITE

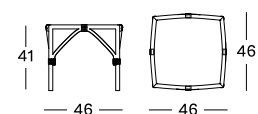

LUCY MODULAR COFFEE TABLE

MATERIALS
powder coated aluminium
polyethylene fibre
glass

DIMENSIONS
75 x 75 cm

COLOUR



OFF WHITE

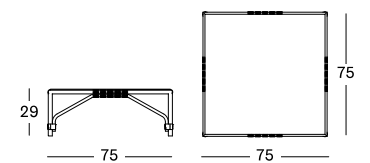

SAFI

Safi stands for timeless outdoor pleasure. The handwoven furniture gives your terrace a royal comfort and adapts naturally to each environment.



LOUNGE CHAIR - LOUNGE SOFA - SIDE TABLE - SUNLOUNGER - DINING CHAIR - DINING TABLE



SAFI LOUNGE SOFA 2S, LOUNGE SOFA 3S AND LOUNGE CHAIR old lace



LEFT PAGE: SAFI SUNLOUNGER old lace
RIGHT PAGE: SAFI DINING CHAIR AND DINING TABLE old lace





SAFI DINING CHAIR

MATERIALS
powder coated aluminium frame
polyethylene fibre

CUSHION
4 cm polyether foam

COLOUR



OLD LACE

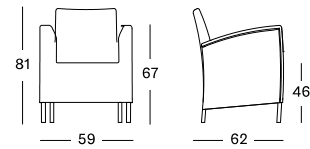

SAFI LOUNGE CHAIR

MATERIALS
powder coated aluminium frame
polyethylene fibre

CUSHION
seat 12 cm quick dry foam
back polyester fibre

COLOUR



OLD LACE

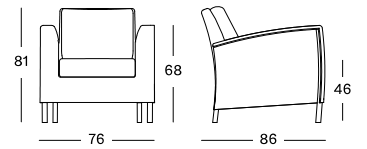

SAFI DINING TABLE DIA 120

MATERIALS
powder coated aluminium frame
polyethylene fibre
glass (optional)

DIMENSIONS
Ø 120 cm

COLOUR



OLD LACE

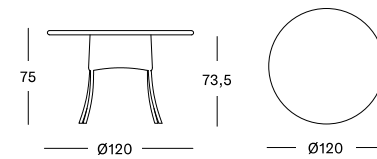

SAFI LOUNGE SOFA 2S

MATERIALS
powder coated aluminium frame
polyethylene fibre

CUSHION
seat 12 cm quick dry foam
back polyester fibre

COLOUR



OLD LACE

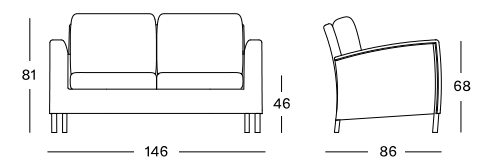

SAFI SUNLOUNGER

MATERIALS
powder coated aluminium frame
polyethylene fibre

CUSHION
3 cm polyether foam

COLOUR



OLD LACE

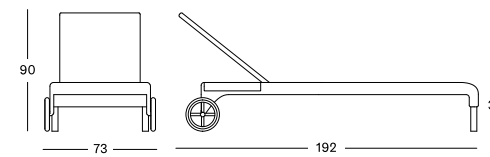

SAFI LOUNGE SOFA 3S

MATERIALS
powder coated aluminium frame
polyethylene fibre

CUSHION
seat 12 cm quick dry foam
back polyester fibre

COLOUR



OLD LACE

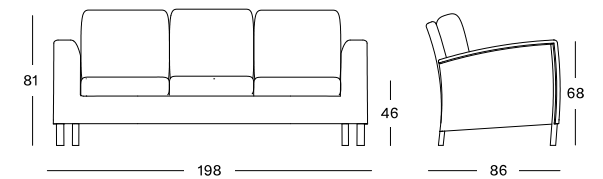

SAFI SUNLOUNGER WITH ARMS

MATERIALS
powder coated aluminium frame
polyethylene fibre

CUSHION
3 cm polyether foam

COLOUR



OLD LACE

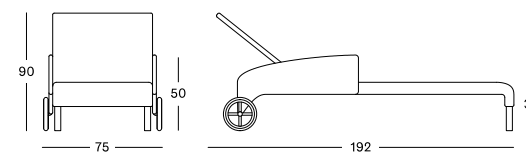

SAFI SIDE TABLE

MATERIALS
powder coated aluminium frame
polyethylene fibre
glass (optional)

DIMENSIONS
60 x 60 cm

COLOUR



OLD LACE

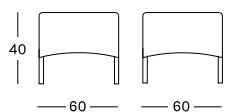



KENZO DINING CHAIR old lace



MIA DINING CHAIR

MATERIALS

aluminium frame
polyethylene wicker

CUSHIONS

4 cm polyether foam

COLOURS



OLD LACE

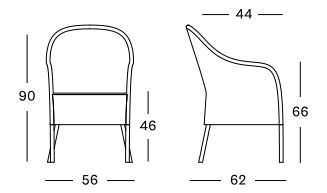

KENZO DINING CHAIR

MATERIALS

aluminium frame
polyethylene wicker

CUSHIONS

4 cm polyether foam

COLOURS



OLD LACE

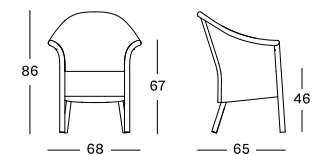

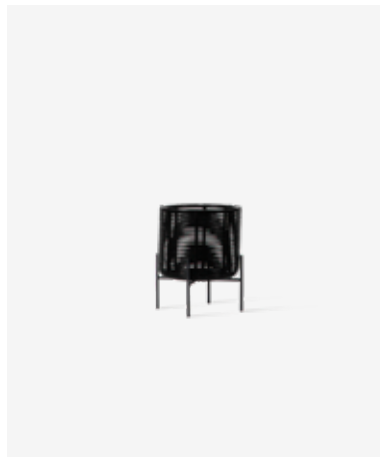

IVO PLANT STAND SMALL

MATERIALS

powder coated aluminium
HDPE wicker
plastic saucer

DIMENSIONS

36 cm H x Ø 29 cm

COLOUR



BLACK ALUMINIUM
BLACK WICKER

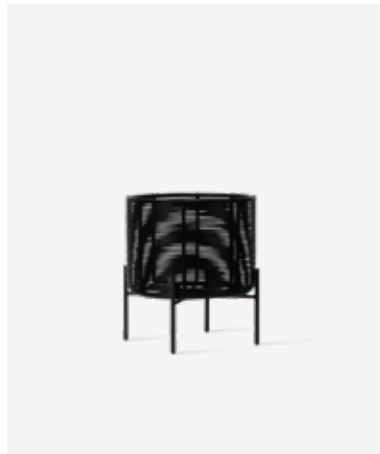
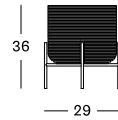

IVO PLANT STAND MEDIUM

MATERIALS

powder coated aluminium
HDPE wicker
plastic saucer

DIMENSIONS

45 cm H x Ø 40 cm

COLOUR



BLACK ALUMINIUM
BLACK WICKER

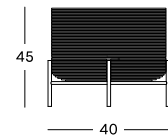

IVO PLANT STAND LARGE

MATERIALS

powder coated aluminium
HDPE wicker
plastic saucer

DIMENSIONS

65 cm H x Ø 29 cm

COLOUR



BLACK ALUMINIUM
BLACK WICKER

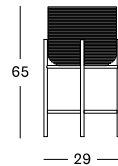

OUTDOOR LLOYD LOOM

Lloyd Loom weave is a unique material made of steel and paper. The strong and flexible material is coated with latex for outdoor use.



LOUNGE CHAIR - LOUNGE SOFA - FOOTREST - SIDE TABLE - COFFEE TABLE - SUNLOUNGER - DINING CHAIR - DINING TABLE







LEFT PAGE: DOVILE DINING CHAIR pure white
RIGHT PAGE: MONTE CARLO DINING CHAIR AND AVIGNON SIDE TABLE pure white



DOVILE DINING CHAIR

MATERIALS
powder coated aluminium frame
outdoor treated Lloyd Loom weave

CUSHION
seat 4 cm polyether foam

COLOURS
see page 167

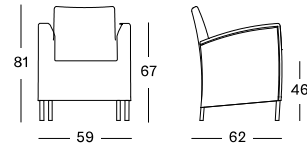

NIMES TABLE DIA 110 / 130

MATERIALS
powder coated aluminium frame
outdoor treated Lloyd Loom weave
glass (optional)

DIMENSIONS
Ø 110 cm
Ø 130 cm

COLOURS
see page 167

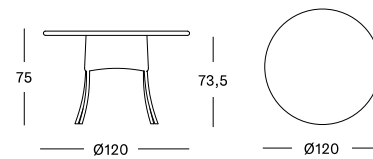

DOVILE FOOTREST

MATERIALS
powder coated aluminium frame
outdoor treated Lloyd Loom weave

CUSHIONS
seat 11 cm polyether foam

COLOURS
see page 167

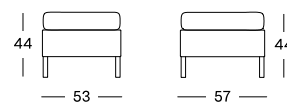

DOVILE SIDE TABLE

MATERIALS
powder coated aluminium
outdoor treated Lloyd Loom weave
glass (optional)

DIMENSIONS
60 x 60 cm

LOOM COLOURS
see page 167

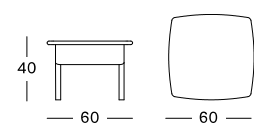

DOVILE LOUNGE CHAIR

MATERIALS
powder coated aluminium frame
outdoor treated Lloyd Loom weave

CUSHIONS
seat 12 cm high resilience foam
back polyester fibre

COLOURS
see page 167

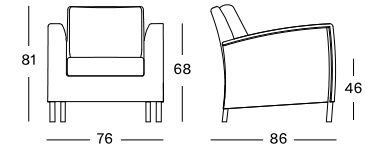

DOVILE LOUNGE SOFA 2S

MATERIALS
powder coated aluminium frame
outdoor treated Lloyd Loom weave

CUSHIONS
seat 12 cm high resilience foam
back polyester fibre

COLOURS
see page 167

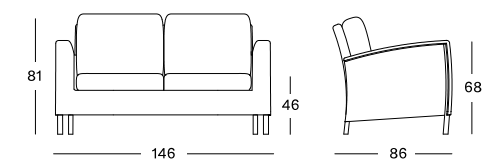

DOVILE LOUNGE SOFA 3S

MATERIALS
powder coated aluminium frame
outdoor treated Lloyd Loom weave

CUSHIONS
seat 12 cm high resilience foam
back polyester fibre

COLOURS
see page 167

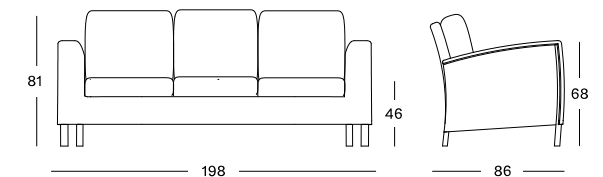

DOVILE COFFEE TABLE

MATERIALS
powder coated aluminium frame
outdoor treated Lloyd Loom weave
glass (optional)

DIMENSIONS
60 x 106 cm

LOOM COLOURS
see page 167

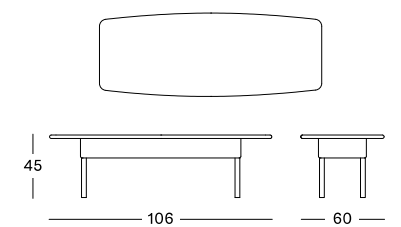



DOVILE SUNLOUNGER WITH ARMS

MATERIALS
powder coated aluminium frame
outdoor treated Lloyd Loom weave

CUSHION
seat 3 cm polyether foam

LOOM COLOURS
see page 167

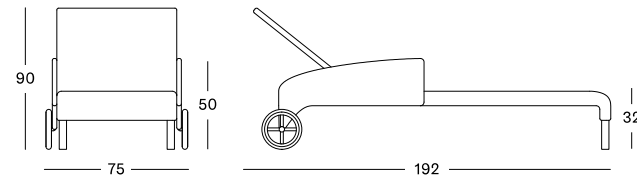

NICE DINING CHAIR

MATERIALS
powder coated aluminium frame
outdoor treated Lloyd Loom weave

CUSHION
seat 4 cm polyether foam

LOOM COLOURS
see page 167

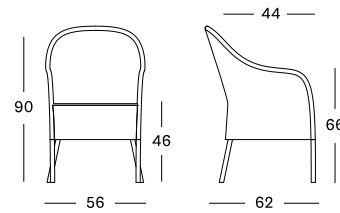

MONTE CARLO DINING CHAIR

MATERIALS
powder coated aluminium frame
outdoor treated Lloyd Loom weave

CUSHION
seat 4 cm polyether foam

LOOM COLOURS
see page 167

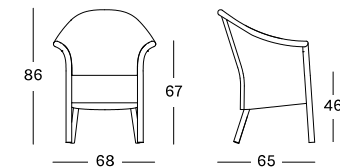

AVIGNON SIDE TABLE

MATERIALS
powder coated aluminium frame
outdoor treated Lloyd Loom weave
glass (optional)

DIMENSIONS
60 cm H x Ø 60 cm

LOOM COLOURS
see page 167

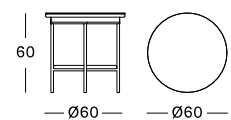

LLOYD LOOM COLOURS

SOLID COLOURS

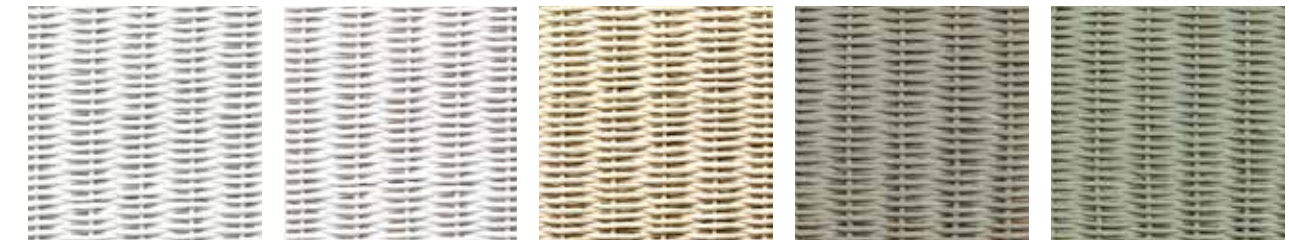

PURE WHITE
P024

SNOW
P020

BROKEN WHITE
P026

PEBBLE
P025

DUSTY GREEN
P050

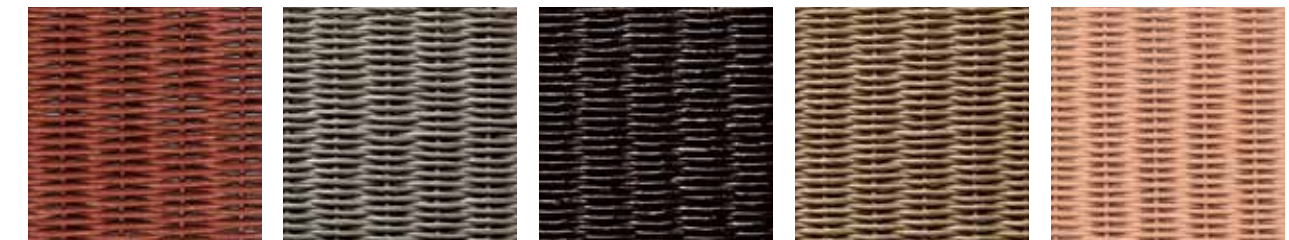

TERRACOTTA
P035

QUARTZ GREY
P086

BLACK
P080

TAUPE
P084

DUSTY CORAL
P034

METALLIC FINISH

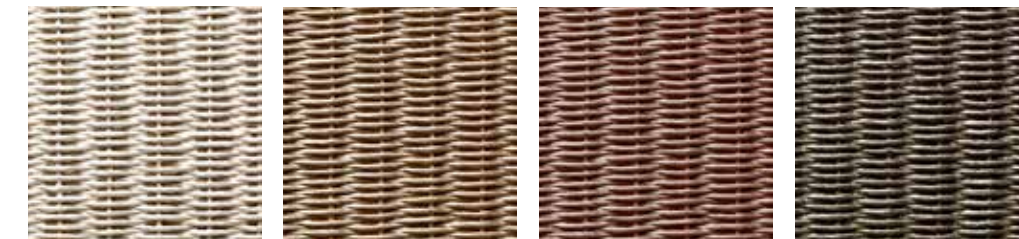

SPARKLE
P033

NACRÉ
P023

COPPER
P079

OYSTER
P036

All colours shown here are as close to the actual colours as the printing process allows.
Swatches can be supplied on request.



DECO CUSHION

DIMENSION
60 x 60 cm

FABRICS
see page 174 - 175



DECO CUSHION

DIMENSION
50 x 50 cm

FABRICS
see page 174 - 175



DECO CUSHION

DIMENSION
45 x 50 cm

FABRICS
see page 174 - 175



DECO CUSHION

DIMENSION
40 x 40 cm

FABRICS
see page 174 - 175



DECO CUSHION

DIMENSION
35 x 50 cm

FABRICS
see page 174 - 175

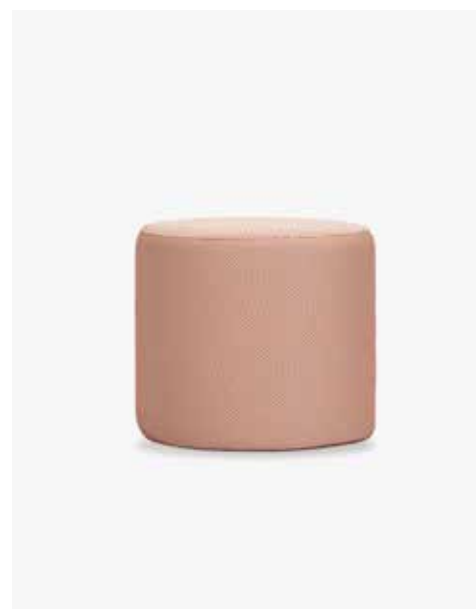

OLAF DIA 50

MATERIALS
breathable polyester
polystyrene beads

DIMENSIONS
40 cm H x Ø 50 cm

COLOURS
quick ship or com fabric

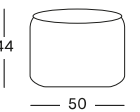

OLAF DIA 80

MATERIALS
breathable polyester
polystyrene beads

DIMENSIONS
40 cm H x Ø 80 cm

COLOURS
Quick ship or com fabric

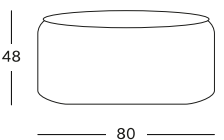

OTTO

MATERIALS
breathable polyester
polystyrene beads

DIMENSIONS
42 cm H x Ø 52 cm

COLOURS

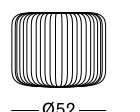

TECHNICAL INFORMATION

TEAK

Teak is a tropical hardwood which is known for its strength and durability. Our teak furniture is delivered untreated and will develop a beautiful silvery grey patina. Clean your table once a year with warm soapy water to discourage moss. If you wish to protect your furniture against stains, we recommend treating teak furniture with a teak sealant. As teak is a natural product, small cracks may develop over time.

ALUMINIUM

Aluminium is a light-weight material which is mainly used as an alternative for steel. Aluminium has a self-protective layer, which prevents corrosion and makes this material very suitable for outdoor applications. Our aluminium furniture is powder coated, which enables us to offer a wide variety of colours. On top of that, it is super easy to maintain. A quick wash with a non-foaming mild detergent every now and then is all it needs!

SYNTHETIC WEAVE

For our all-weather outdoor collection, we use multiple synthetic materials, including polyethylene, polypropylene, and HDPE wicker. All our synthetic materials are specifically designed to withstand any weather conditions, are UV-resistant, and can be left outside all year long. We recommend giving them a quick wash when dirty or every three months with a non-foaming mild detergent.

100% SOLUTION DYED ACRYLIC

- may be machine-washed at 40°C
- may be tumble dried
- may be ironed, ironing temperature should not be higher than 110°C
- the fabric may be treated with bleach
- may be dry cleaned

ACRYLIC ROPE

- may be machine-washed at 40°C
- may be tumble dried
- may be ironed, ironing temperature should not be higher than 110°C
- the fabric may be treated with bleach
- may be dry cleaned

POLYPROPYLENE ROPE

- may be machine-washed at 40°C
- may be tumble dried
- may be ironed, ironing temperature should not be higher than 110°C
- the fabric may not be treated with bleach
- do not dry clean



CERAMIC

Ceramic requires little to no maintenance, yet offers maximum resistance. The material preserves the natural look of stone and offers top of the chart convenience. Ceramic is scratchproof, UV-resistant, stainproof, and resistant to fire and high temperatures. Use pure water or a cleaning solution without soap for ceramic surfaces to clean the table. Please do not use soap.

OUTDOOR LOOM

Lloyd Loom weave is made from twisted Kraft paper on the one hand, and Kraft paper spun around a steel wire on the other hand. In order to be able to use Lloyd Loom for outside furniture as well, a specific technique was developed to make the material waterproof. Our outdoor Lloyd Loom models can thus simply be left outside, although we recommend storing them inside during cold or rainy periods.

CUSHIONS

From snuggling between soft pillows to enjoying a dinner party on a lovely dining chair with seat cushion. Comfortable cushions take your seating experience to the next level.

Vincent Sheppard uses high-quality materials and relies on advanced textile technologies to create its cushions. Our fabrics are water-repellent, breathable, and UV-proof. The cushion's cores consist of outdoor foam, enabling you to leave them outdoors during any weather condition. Still, we recommend storing your cushions for the winter or when not in use for long periods.

100% POLYOLEFIN

- may be machine-washed at 40°C with extra care
- do not tumble dry
- may not be ironed
- may be treated with bleach
- do not dry clean

MIX OF MATERIALS

- may be machine-washed at 40°C with extra care
- do not tumble dry
- do not iron
- do not bleach
- do not dry clean

OUTDOOR HPL

HPL or high-pressure laminate is a very sturdy material which consists of different layers which are pressed together under a high temperature. As a result, the material is very durable and UV-resistant. HPL is used for our table tops and can be used indoors as well as outdoors. The table tops do not require any maintenance except for a quick wash every now and then.

STEEL

Steel is mainly used for the legs and frames of our furniture pieces. For the outdoor pieces, the steel is always galvanized and powder coated to make sure it is protected from all weather influences.

RUGS

Vincent Sheppard outdoor rugs are made of polyester fibres. The high-performance rugs are dirt and water-repellent, and are thus easy to maintain. Use a high-pressure water hose to clean spots and blot dry afterwards.

Nearly all our cushion covers are removable which makes them look brand-new after a wash. As every fabric has its own characteristics, different washing instructions apply.



PROTECTIVE COVERS

In order to protect your furniture and keep maintenance minimal, we have developed special protective covers.

The covers are made of 100% polyurethane and have welded, not stitched seams. Consequently, the covers are 100% waterproof.

CAT. B CUSHION FABRICS

Item codes starting with CB or QB



CANVAS S0606
100% SOLUTION DYED ACRYLIC



LIN S1212
100% SOLUTION DYED ACRYLIC

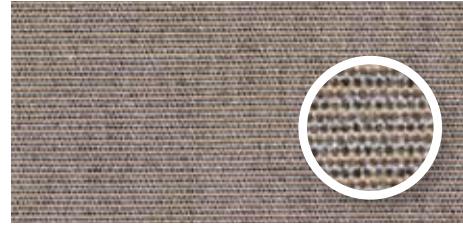

LONDON STONE S0808
100% SOLUTION DYED ACRYLIC

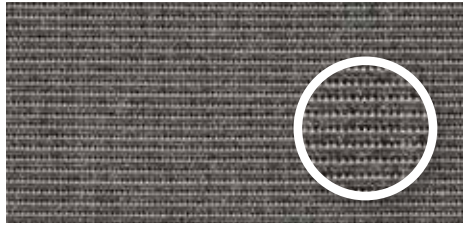

DARK SMOKE S0909
100% SOLUTION DYED ACRYLIC

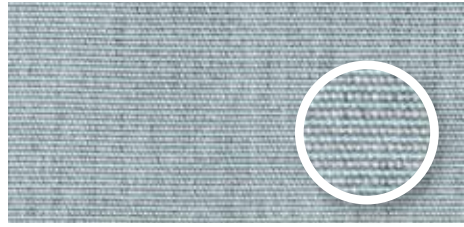

MINERAL BLUE S1010
100% SOLUTION DYED ACRYLIC



BLUSH S2929
100% SOLUTION DYED ACRYLIC



BLACK S1515
100% SOLUTION DYED ACRYLIC

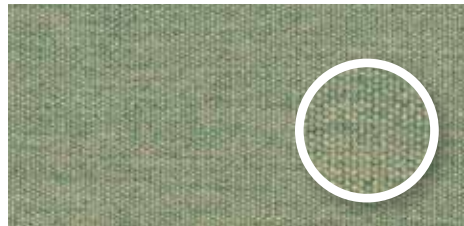

OLIVE GREEN S2727
100% SOLUTION DYED ACRYLIC

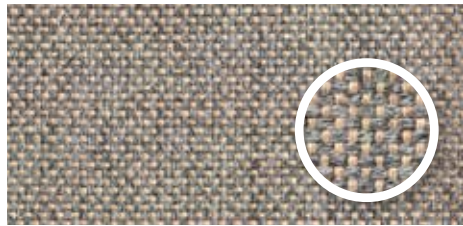

CARBON BEIGE S2828
100% SOLUTION DYED ACRYLIC

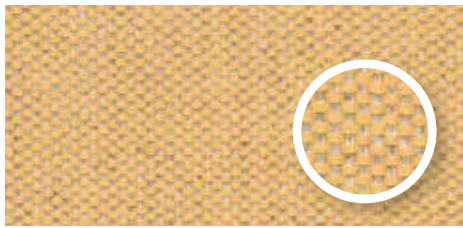

AMBER S3030
100% SOLUTION DYED ACRYLIC

CAT. C CUSHION FABRICS

Item codes starting with CC or QC

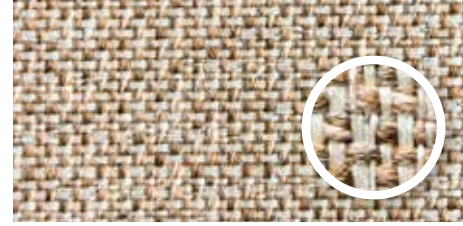

SAVANE COCONUT S2222
100% SOLUTION DYED ACRYLIC

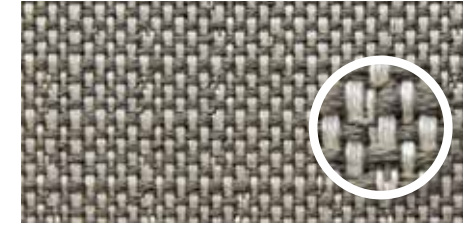

ZINC S2121
100% SOLUTION DYED ACRYLIC

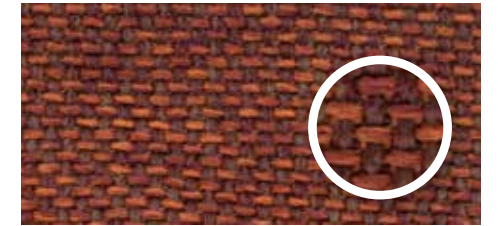

SPICE P0202
100% POLYOLEFIN

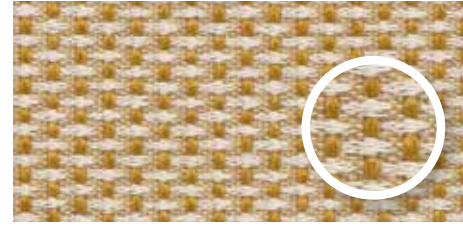

MUSTARD P0505
57% POLYOLEFIN / 43% POLYESTER

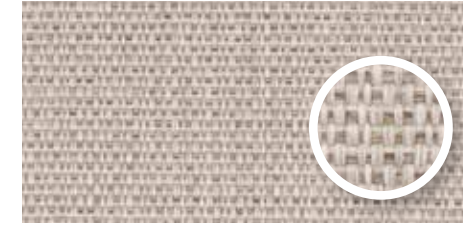

ALMOND P0303
100% POLYPROPYLENE

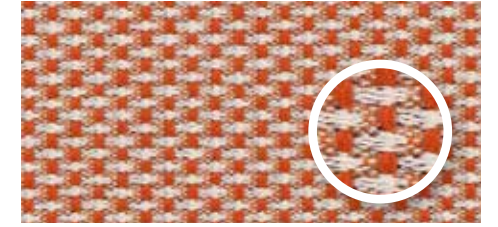

CORAL P0404
57% POLYOLEFIN / 43% POLYESTER

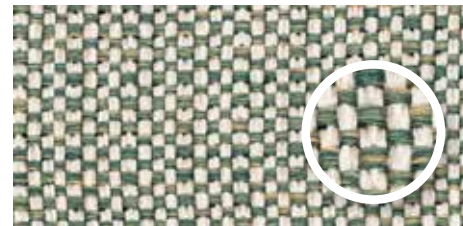
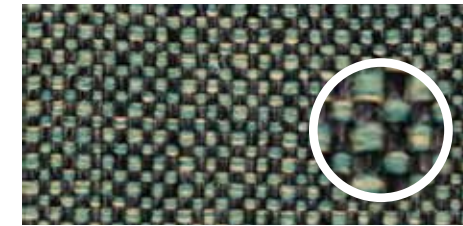

FIG GREEN M0303
100% POLYPROPYLENE



PINE GREEN M0202
100% POLYPROPYLENE

CAT. G CUSHION FABRICS

Item codes starting with CG or QG



LIME WHITE BOUCLÉ M0101
100% POLYPROPYLENE

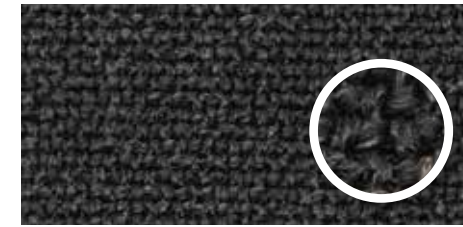

BLACK BOUCLÉ M0404
100% POLYPROPYLENE

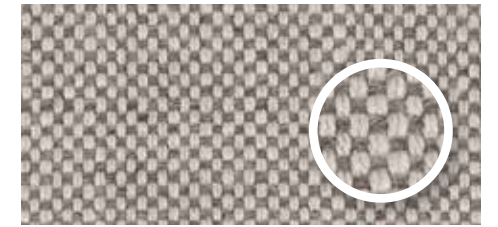

STONE T0202
100% SOLUTION DYED ACRYLIC



KIWI P0707
100% POLYPROPYLENE

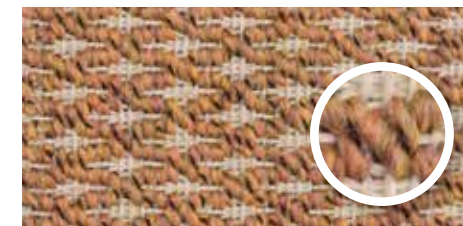

SIENNA M0505
100% POLYPROPYLENE

PRODUCT OVERVIEW

DINING CHAIRS - BAR STOOLS - LOUNGE CHAIRS - SOFAS - FOOTRESTS - POUFFES
SUNLOUNGERS - TABLES - BENCHES - COFFEE TABLES - SIDE TABLES - ACCESSORIES



CLEO DINING CHAIR
P 53



REMI DINING CHAIR
P 63



FREYA DINING ARMCHAIR
P 62



KODO DINING CHAIR
P 32



EDGARD DINING CHAIR
P 129



FRIDA DINING CHAIR
P 11



GIPSY DINING CHAIR
P 131



LEO DINING CHAIR
P 73



LENA DINING CHAIR STEEL A BASE
P 129



LENA DINING CHAIR TEAK BASE
P 129



ROXANNE DINING CHAIR
P 109



ROXY DINING CHAIR
P 109

DINING CHAIRS



LOOP DINING CHAIR
P 91



WICKED DINING CHAIR
P 118



MIA DINING CHAIR SYNTHETIC
P 153



KENZO DINING CHAIR SYNTHETIC
P 153



SAFI DINING CHAIR SYNTHETIC
P 150



MONA DINING CHAIR
P 63



DAVID DINING ARMCHAIR
P 82



NICE DINING CHAIR LLOYD LOOM
P 166



DOVILE DINING CHAIR LLOYD LOOM
P 164



MONTE CARLO DINING CHAIR LLOYD LOOM
P 166

BAR STOOLS



LUCY DINING CHAIR
P 141



LUCY DINING ARMCHAIR
P 141



EDGARD BAR STOOL TEAK BASE
P 130



EDGARD BAR STOOL STEEL BASE
P 130



ODA LOUNGE CHAIR
P 18



CLEO LOUNGE CHAIR
P 53



LENTO LOUNGE CHAIR
P 43



FRIDA LOUNGE CHAIR
P 11



ROY LAZY CHAIR
P 109



ROY COCOON
P 109



DAVID LOUNGE CHAIR
P 83



KODO LOUNGE CHAIR
P 32



LEO LOUNGE CHAIR
P 71



LOOP LOUNGE CHAIR
P 91



KODO ROCKING CHAIR
P 32



KODO COCOON
P 32



GIPSY LOUNGE & GIPSY COCOON
P 131



WICKED LOUNGE CHAIR
P 119



OLAF POUFFE
P 169



OTTO POUFFE (AVAILABLE IN 4 COLOURS)
P 169



DOVILE LOUNGE CHAIR LLOYD LOOM
P 165



SAFI LOUNGE CHAIR SYNTHETIC
P 151



KODO FOOTREST
P 33



LOOP FOOTREST
P 90



DOVILE FOOTREST LLOYD LOOM
P 164



LUCY FOOTREST
P 142



LUCY LAZY ARMCHAIR
P 142



LUCY LOUNGE
P 142



DAVID SUNLOUNGER
P 82



KODO SUNLOUNGER
P 37



LOOP SUNLOUNGER
P 91



KODO DEEP SOFA
P 36



CLEO SOFA
P 53



LUCY SUNLOUNGER
P 141



SAFI SUNLOUNGER SYNTHETIC
P 150



SAFI SUNLOUNGER WITH ARMS SYNTHETIC
P 150



KODO LOUNGE SOFA
P 33



KODO DAYBED
P 33



DOVILE SUNLOUNGER WITH ARMS LLOYD LOOM
P 166



DAVID LOUNGE SOFA 2S
P 83



DAVID LOUNGE SOFA 3S
P 83



**SAFI LOUNGE SOFA 2S
SYNTHETIC**
P 151



**SAFI LOUNGE SOFA 3S
SYNTHETIC**
P 151



ODA LOUNGE SOFA 2.5S
P 18



ODA LOUNGE SOFA 3S
P 18



DOVILE LOUNGE SOFA 2S LLOYD LOOM
P 165



DOVILE LOUNGE SOFA 3S LLOYD LOOM
P 165



LEO LOUNGE SOFA
P 71



LOOP SOFA
P 91



WICKED LOUNGE SOFA 2S
P 119



WICKED LOUNGE SOFA 3S
P 119



LENTO LOUNGE SOFA 2.5S
P 43



LENTO LOUNGE SOFA 3S
P 43



KODO MODULAR SET
P 32



LENTO MODULAR SET
P 44



KODO MODULAR 2 SEATER RIGHT
P 34



KODO MODULAR CORNER
P 35



KODO MODULAR 2 SEATER LEFT
P 35



LENTO MODULAR CORNER LEFT
P 44



LENTO MODULAR CORNER RIGHT
P 44



KODO MODULAR 1 SEATER RIGHT
P 34



KODO MODULAR CENTER
P 34



KODO MODULAR COFFEE TABLE
P 36



KODO MODULAR 1 SEATER LEFT
P 35



LENTO CHAISE LONGUE RIGHT
P 45



LENTO CHAISE LONGUE LEFT
P 45



KODO MODULAR CHAISE LONGUE RIGHT
P 34



KODO MODULAR OTTOMAN
P 36



KODO MODULAR CHAISE LONGUE LEFT
P 35



LENTO MODULAR OTTOMAN
P 45



LENTO MODULAR CONNECTING SIDE TABLE
P 44

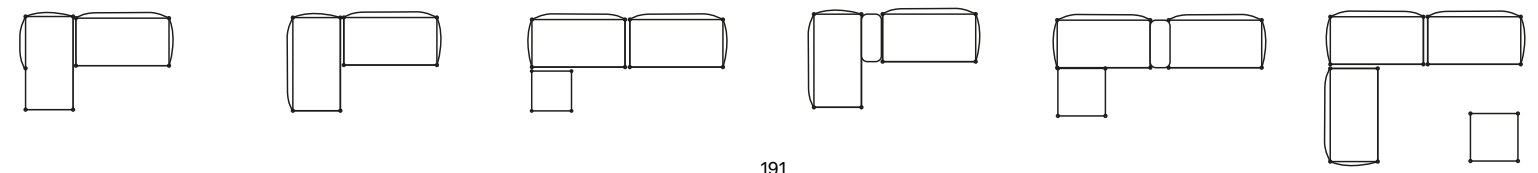
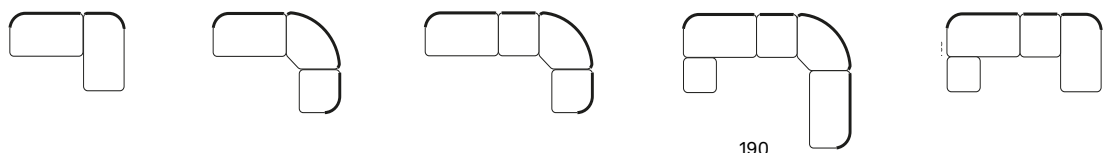



LEO MODULAR SET
P 70



LUCY MODULAR SET
P 143



LEO MODULAR CORNER RIGHT
P 70



LEO MODULAR CORNER LEFT
P 70



LUCY MODULAR CORNER
P 143



LUCY MODULAR CENTER
P 143



LEO MODULAR CENTER
P 70



LEO MODULAR COFFEE TABLE
P 70



LEO MODULAR FOOTREST
P 70



LUCY MODULAR OTTOMAN
P 143



LUCY MODULAR COFFEE TABLE
P 143

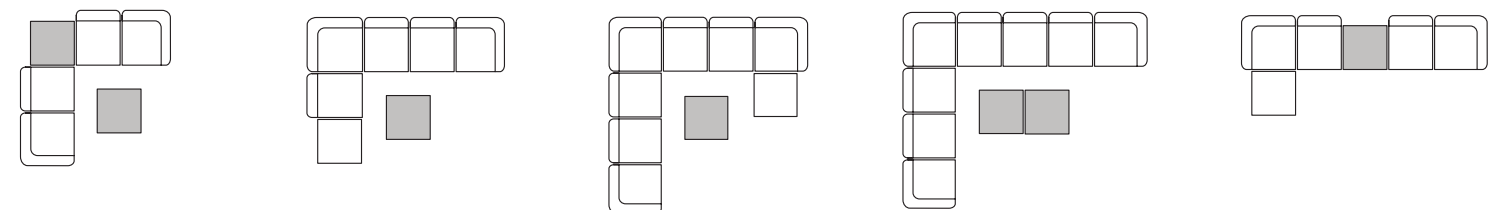
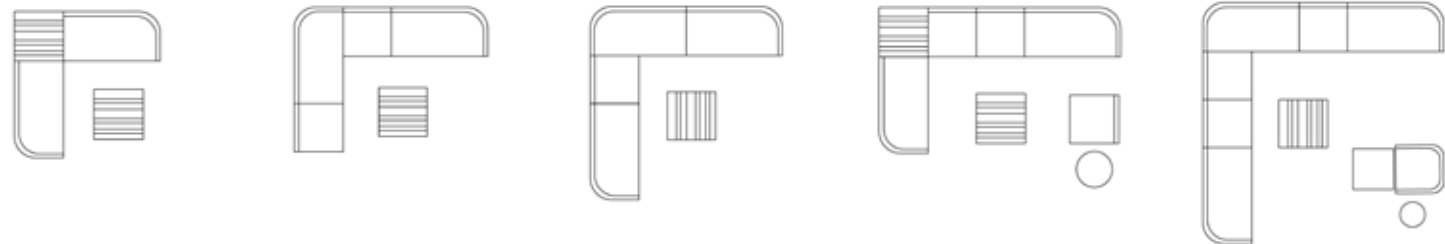



ODA COFFEE AND SIDE TABLES
P 19



DAVID COFFEE TABLE 129 X 45 & SIDE TABLE 41 X 41
P 83



DAVID COFFEE TABLE 120 X 120
P 83



IVO COFFEE AND SIDE TABLE
P 132



WICKED COFFEE TABLE & SIDE TABLE
P 118



KODO COFFEE TABLE & SIDE TABLE
P 37



KODO ROUND COFFEE TABLES & SIDE TABLE
P 36 | 37



LENTO COFFEE & SIDE TABLES
P 43



DAVID COFFEE TABLE DIA 68 & SIDE TABLE DIA 40
P 82



LILO COFFEE AND SIDE TABLES
P 53



AVIGNON SIDE TABLE LLOYD LOOM
P 71



DOVILE COFFEE AND SIDE TABLE LLOYD LOOM
P 11



LEO COFFEE & SIDE TABLES
P 166



ANTON TEAK COFFEE AND SIDE TABLES
P 164 | 165



SAFI SIDE TABLE SYNTHETIC
P 111



LUCY SIDE TABLE
P 111



ROZY COFFEE TABLE
P 151



ROZY SIDE TABLE
P 142



LOOP COFFEE TABLE
P 90



LOOP SIDE TABLE
P 90



VOLTA DINING TABLE
P 62



WICKED DINING TABLE
P 118



DAVID DINING TABLE
P 82



KODO DINING TABLE
P 33



SAM DINING TABLE
P 11 | 62



NOA DINING TABLE
P 62



LEO DINING TABLE
P 73



MAX DINING TABLE
P 73 | 108



MATTEO DINING TABLE
P 130



MATTEO BENCH
P 130



RONDA BISTRO TABLE
P 108



SPHERA BISTRO TABLE
P 108



QUADRO BISTRO TABLE
P 108



NIMES DINING TABLE LLOYD LOOM
P 164



SAFI DINING TABLE SYNTHETIC
P 150



TIKA LANTERN
P 99



MORA LAMP
P 100



MAYA LAMP
P 96



IVO PLANT STAND
P 154



LIGHT MY TABLE
P 99



TOUNDRA RUG AND CLIFF RUG
P 74

Vincent Sheppard showroom

Doornikserijksweg 193A
8510 Bellegem - Belgium

On appointment only

Vincent Sheppard HQ

Industriepark 5
8587 Spiere - Belgium
+32 56 46 11 11
info@vincentsheppard.com
www.vincentsheppard.com



